

Electromagnetic Radiation: Characteristics

transversal waves, velocity $c_0 \approx 3 \cdot 10^8 \text{ m s}^{-1}$

1. Energy (eV, kJ mol⁻¹)

-frequency ν ($\nu = c_0 / \lambda$; s⁻¹, Hz)

-wavelength λ ($\lambda = c_0 / \nu$; Å, nm, ..., m, ...)

-wavenumber $\tilde{\nu}$ ($\tilde{\nu} = 1/\lambda = \nu/c_0$; cm⁻¹, Kaiser)

energy \sim frequency ($E = h \cdot \nu$)

\sim wavenumber ($E = h \cdot \tilde{\nu} \cdot c_0$)

\sim wavelength⁻¹ ($E = h \cdot c_0 / \lambda$)

2. Intensity cross-section $I \sim |\vec{S}|^2 = |\vec{E} \times \vec{H}|$

3. Direction wavevector \vec{s}_0

4. Phase phase φ

Range of frequencies for structural analysis: 10⁶-10²⁰ Hz, 10² -10⁻¹²m, 10⁻⁸-10⁶ eV
radio-, microwaves, infrared (IR), visible (VIS), ultraviolet (UV), X-ray, γ -ray¹

Electromagnetic radiation: Spectral ranges

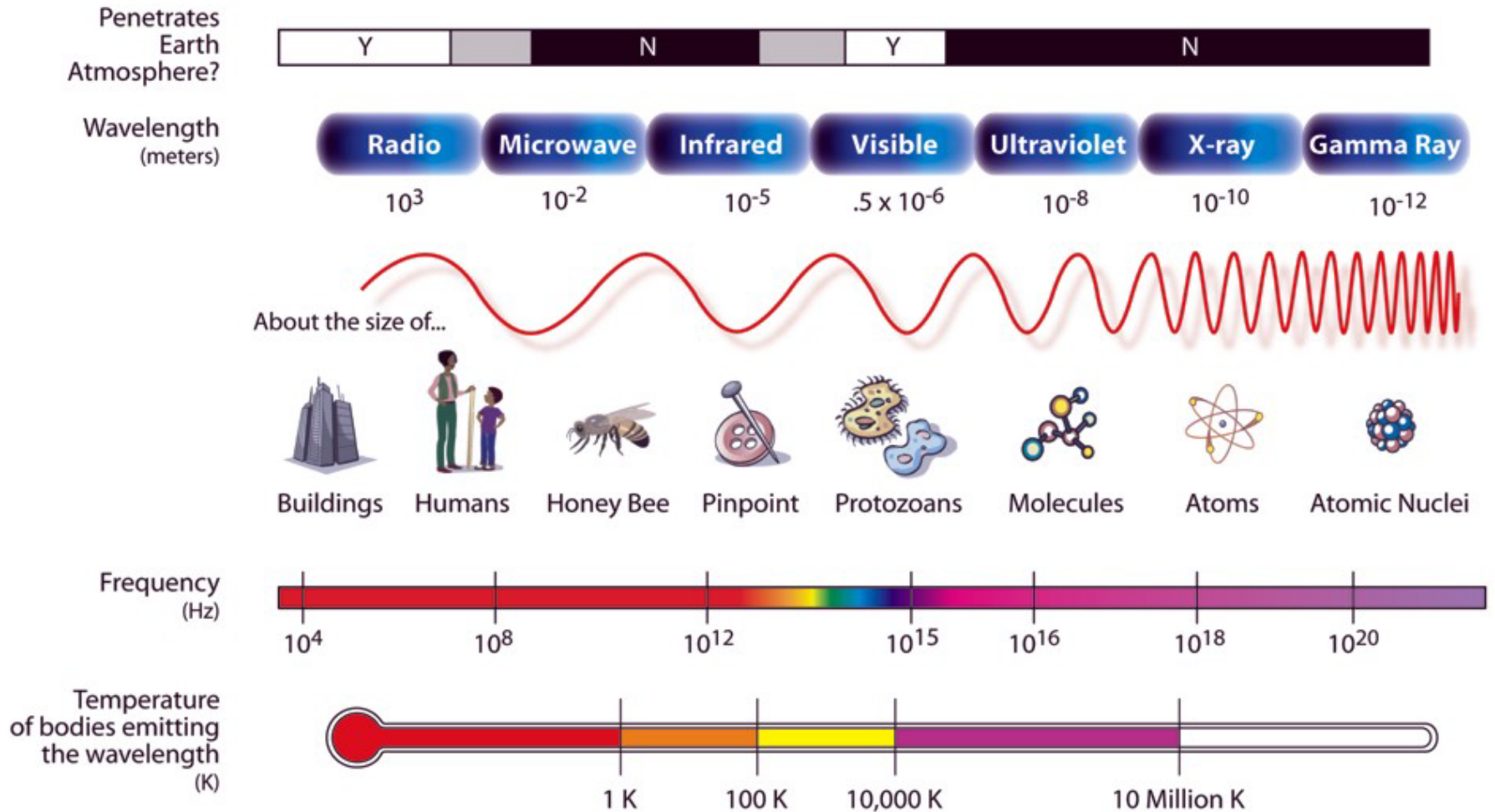

Orders of magnitude in wavelength, frequency, energy, temperature

Electromagnetic radiation: Spectral ranges

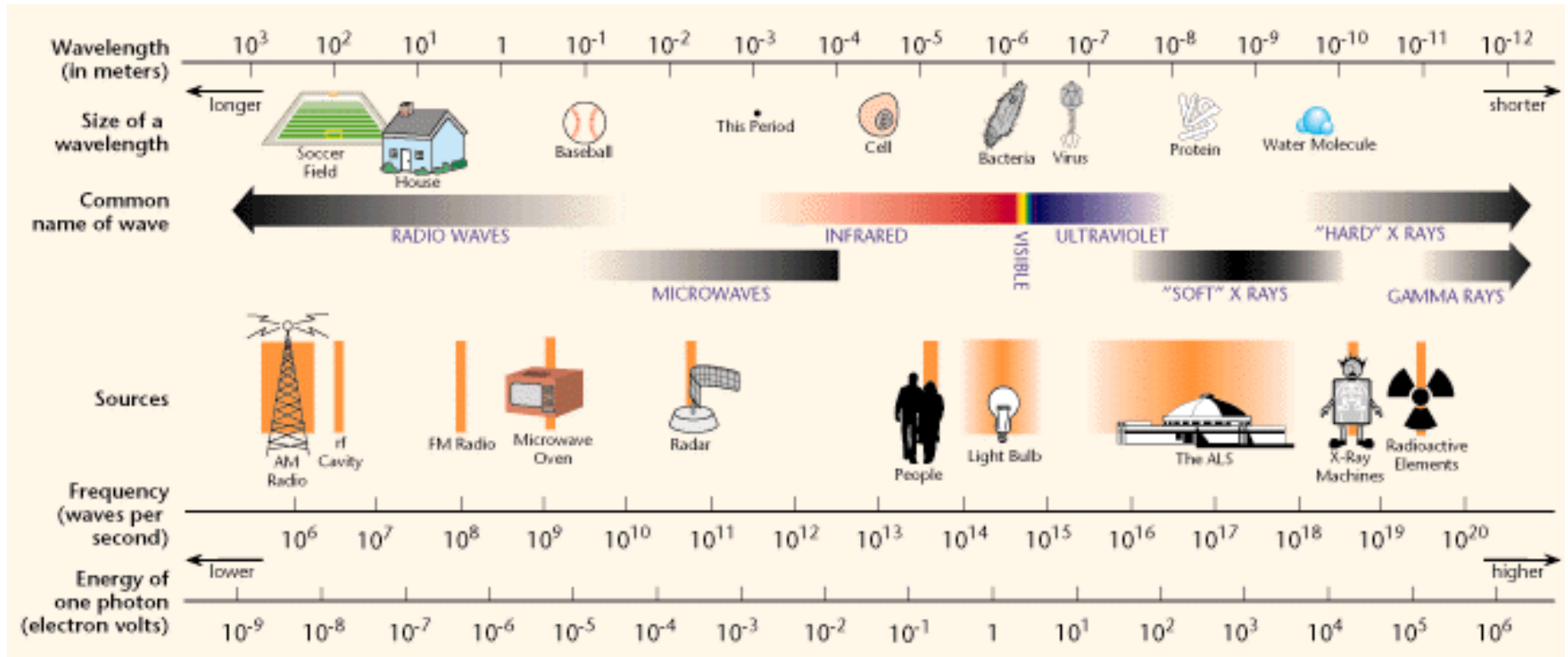

$$1 \text{ eV} = 1,602 \cdot 10^{-19} \text{ J} = 96,485 \text{ kJ mol}^{-1} = 8065,5 \text{ cm}^{-1}$$

Orders of magnitude in wavelength, frequency, energy, temperature

Electromagnetic radiation: Spectral ranges

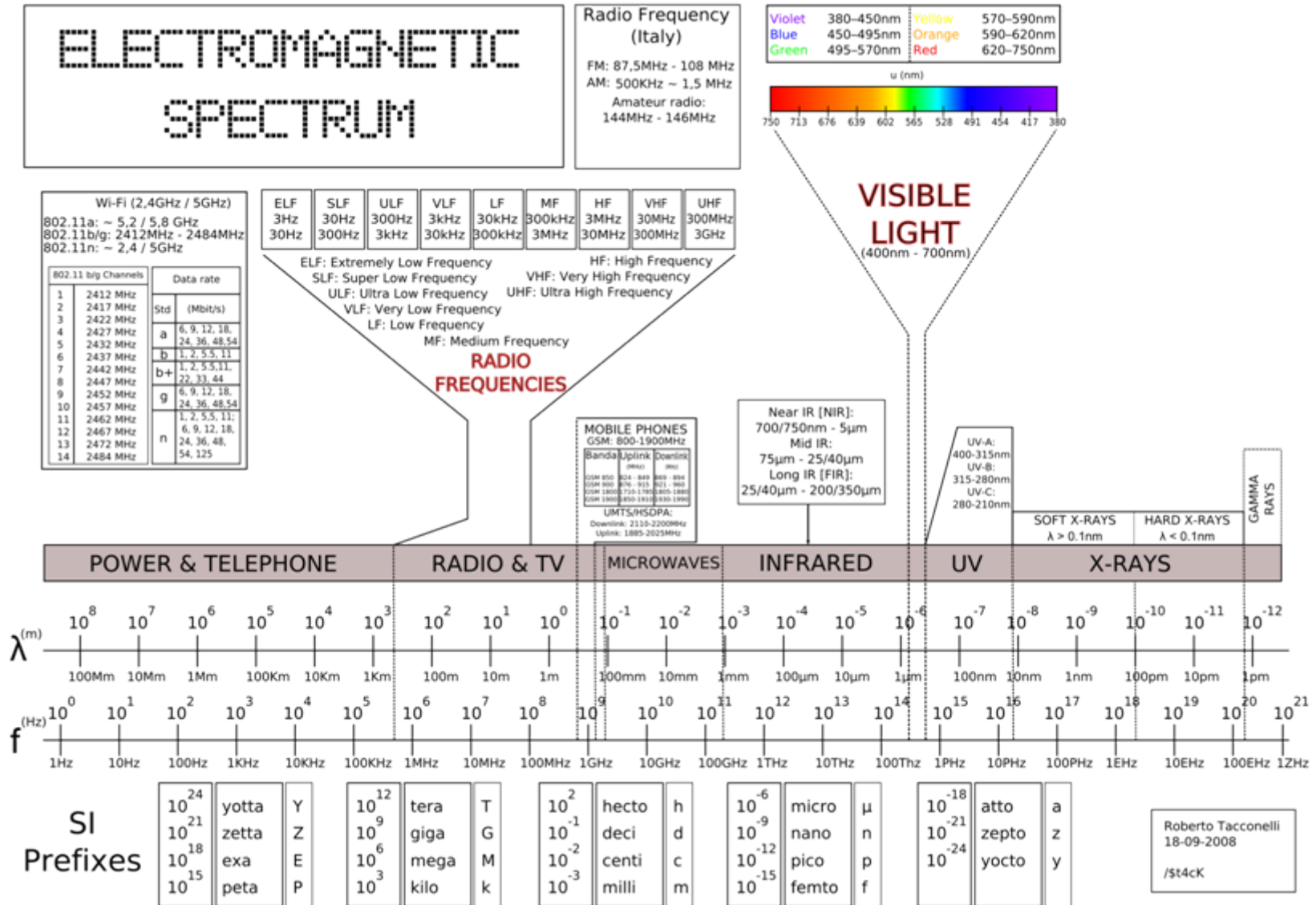

Electromagnetic radiation: Spectral ranges

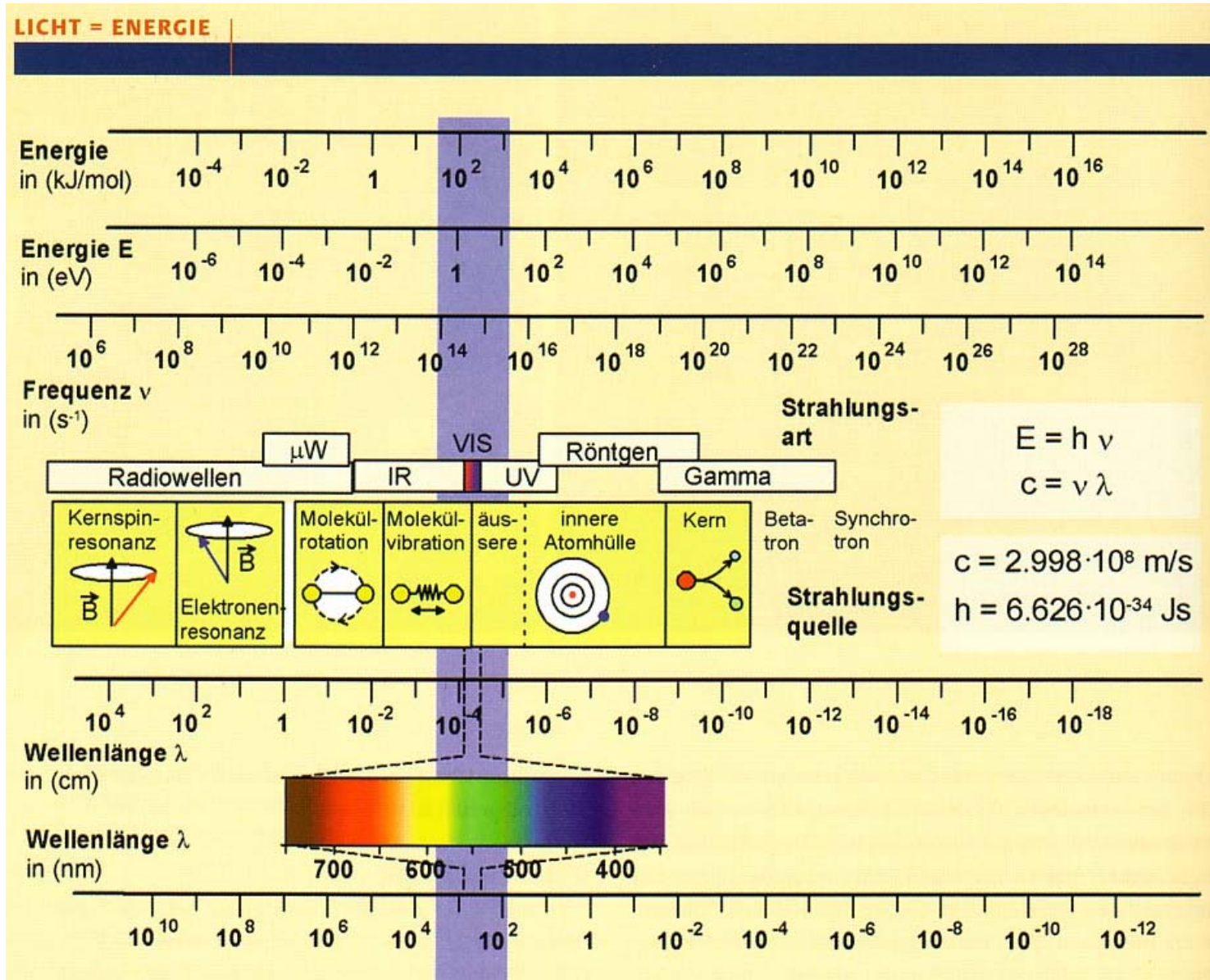

Electromagnetic radiation: Origins and techniques

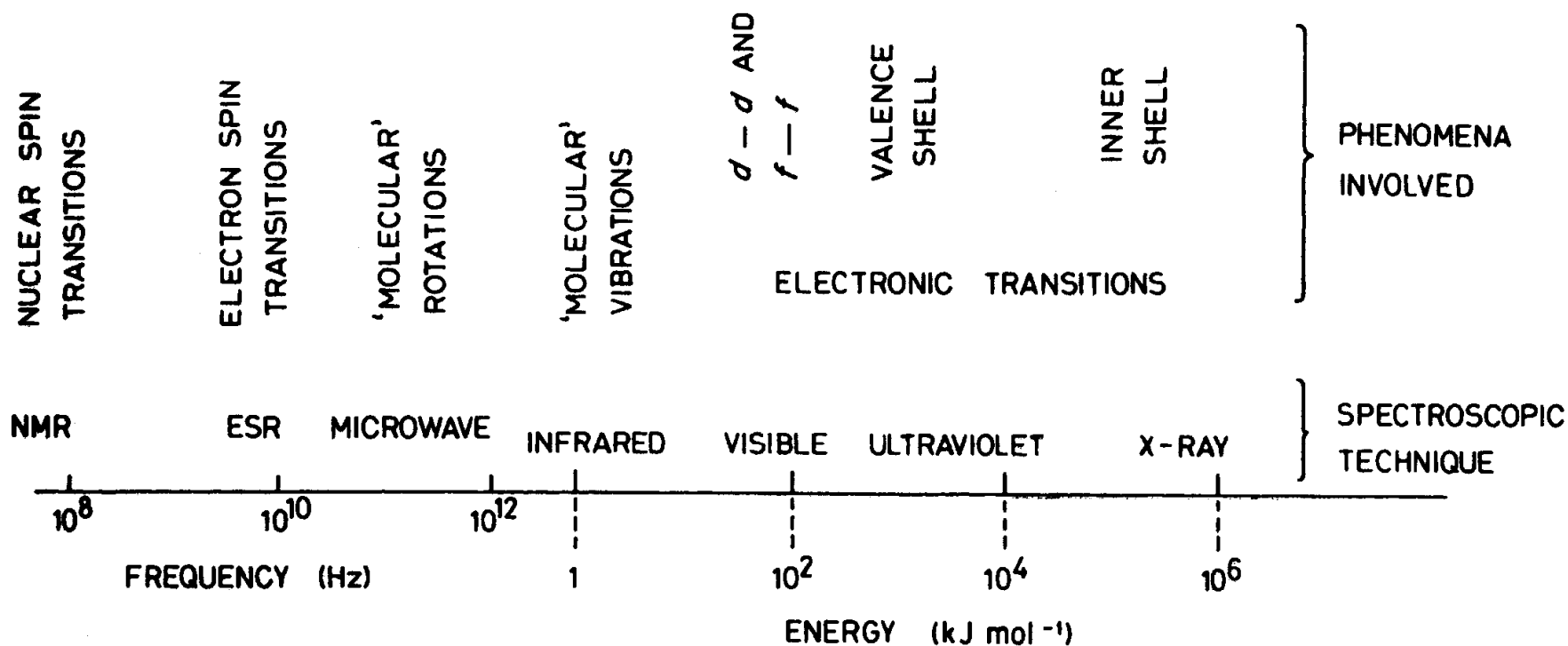

Electromagnetic radiation: Sources

Radio waves/NMR



Radio valve, 500 W
graphite anode



Anode

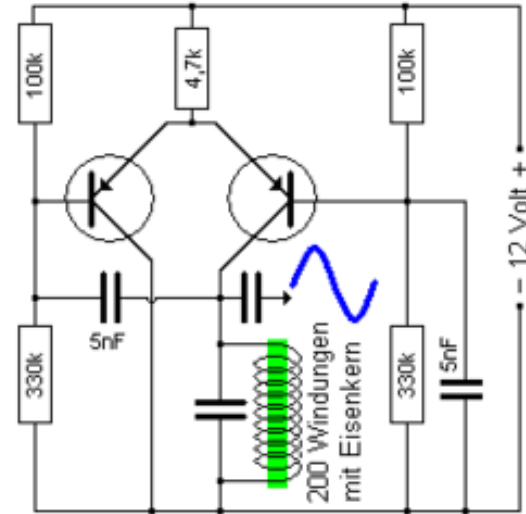

Sinus-Oszillator für etwa 1 kHz mit PNP-Transistoren.

$$f = \frac{1}{2\pi} \sqrt{\frac{1}{LC}}$$

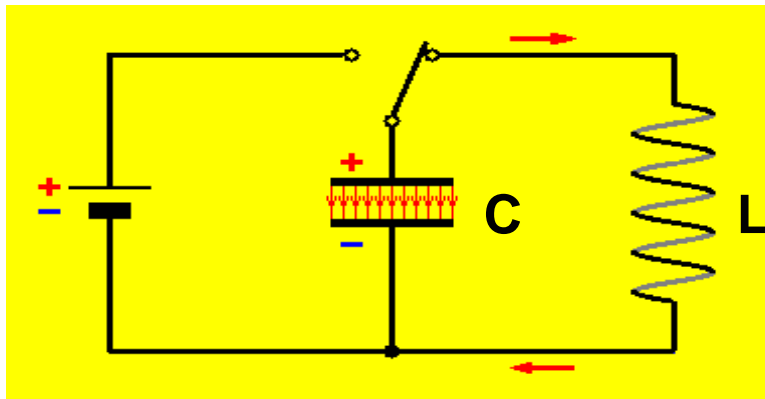

Electromagnetic waves are produced (a.o.), when charges or charged or dipolar species are oscillating with frequencies in the respective range. For microwaves, the charges oscillate in a resonance or tank circuit, consisting of a capacitor with capacitance C and a coil with self-inductance L .

Electromagnetic radiation: Sources

Microwave radiation

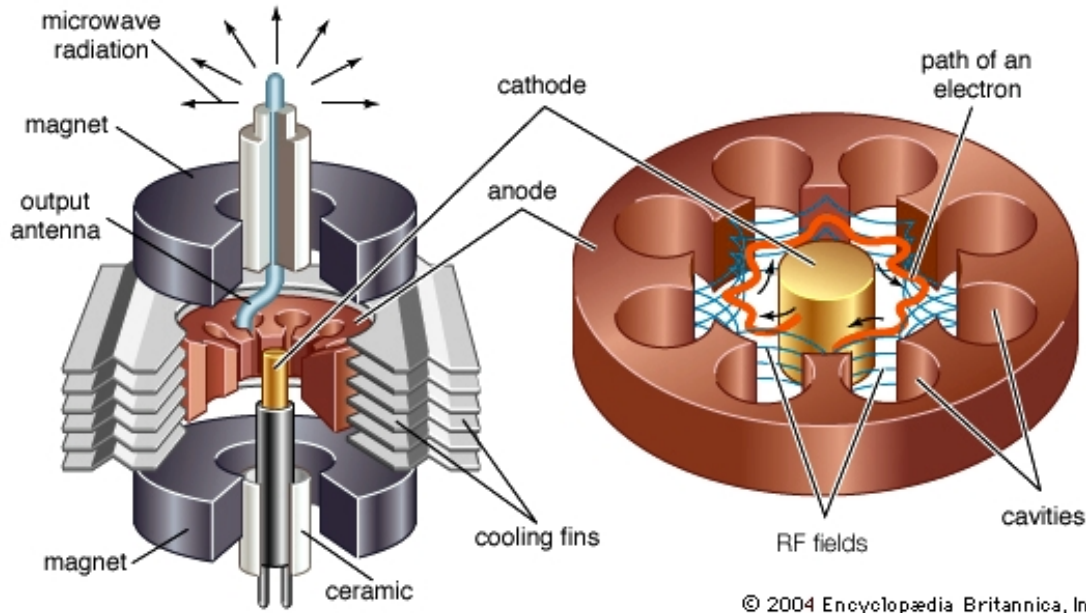

© 2004 Encyclopædia Britannica, Inc.

Schematic view of a magnetron for the production of microwaves (left) and the anode with an even number of anode vanes (right)

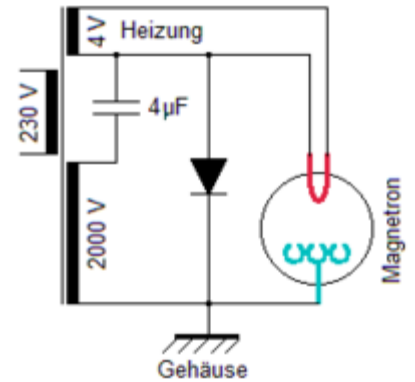

Principal circuit of a magnetron



Impulsmagnetron MI-189W (ca. 9 GHz) Bordradar, Russia

Magnetrons and Gyrotrons are diode-type electron tubes ($\sim 1-10$ kV) with a trapezoid anode (*resonant cavities*) surrounded by permanent magnets producing an axial magnetic field. Under the combined influence of the electric and the magnetic field, the electrons are forced in a circular motion of travel to the anode resulting in electromagnetic radiation of 0.3 - 300 GHz .

Electromagnetic radiation: Sources

IR-Sources, Globar, Nernst lamp



new

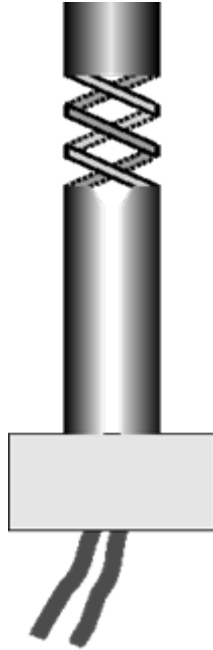

sketch



used

Globar (SiC, ~1.500 K)

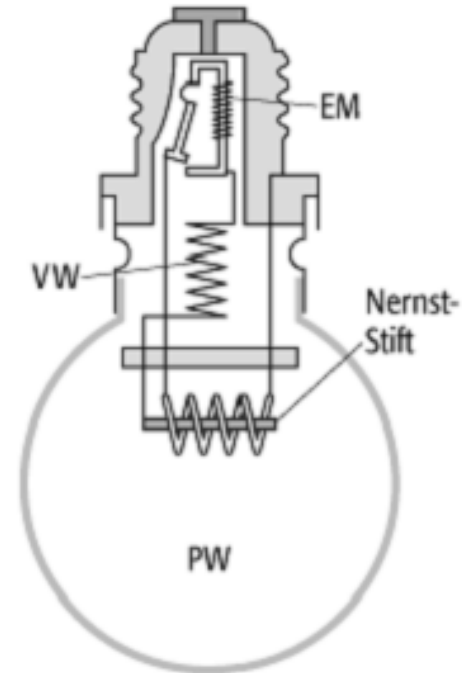

Nernst lamp with Nernst rod, a $\text{ZrO}_2/\text{Y}_2\text{O}_3$ ion conductor 1.900 K

Any heated material will produce infrared radiations

Electromagnetic radiation: Sources

UV and NIR radiation

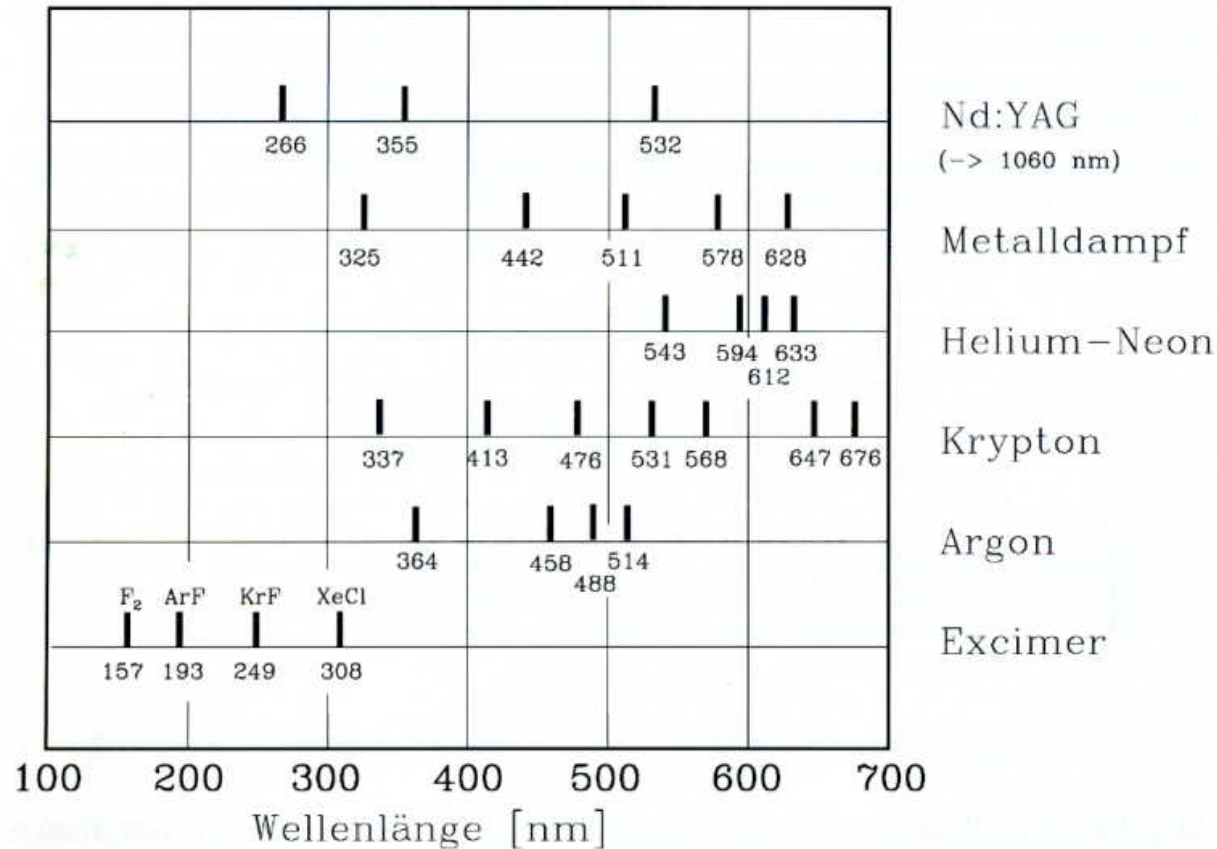

Wave lengths of some lasers for UV, visible and Raman spectroscopy

Electromagnetic radiation: Sources

UV and NIR radiation

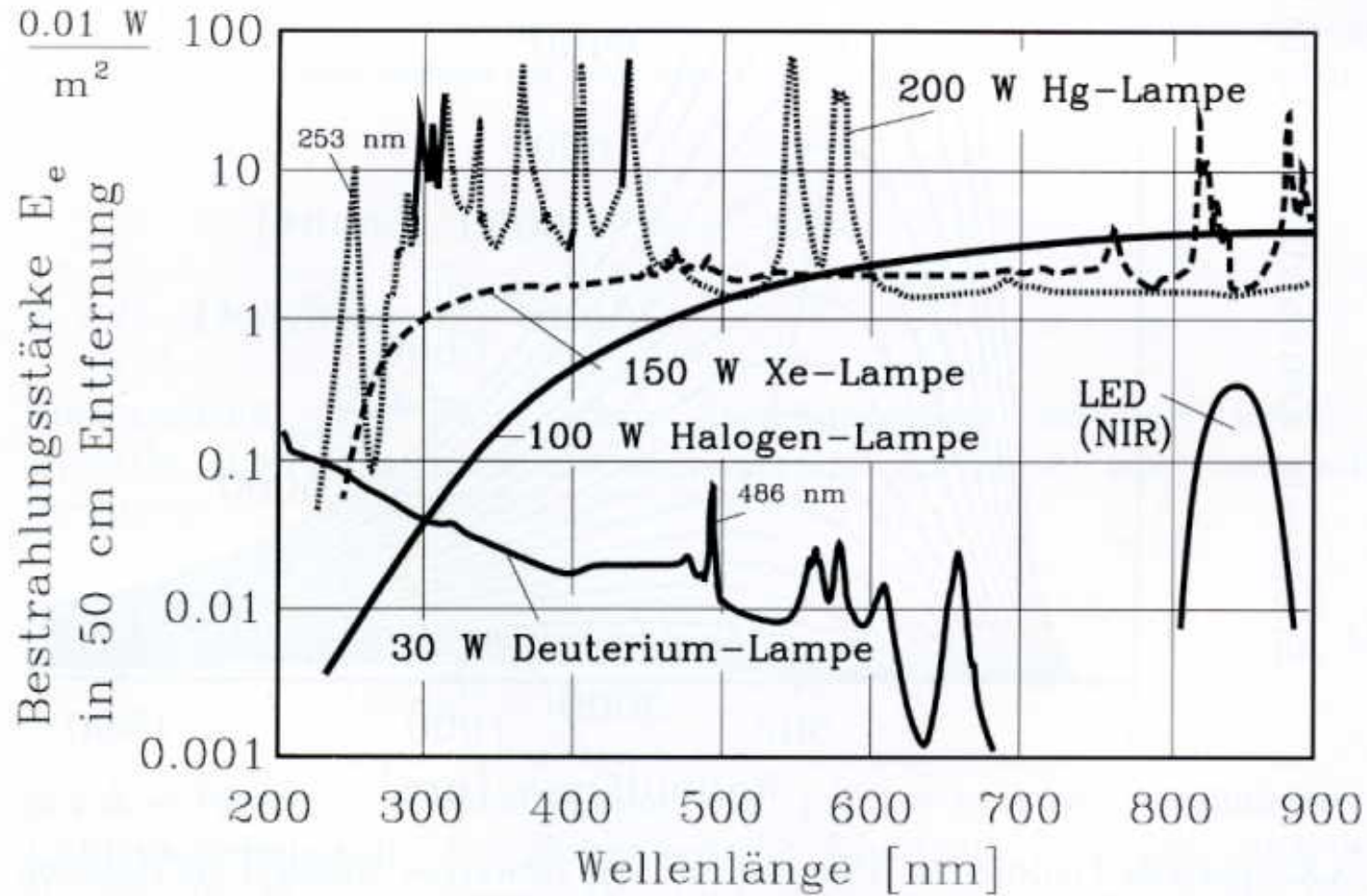

Electromagnetic radiation: Sources

UV radiation

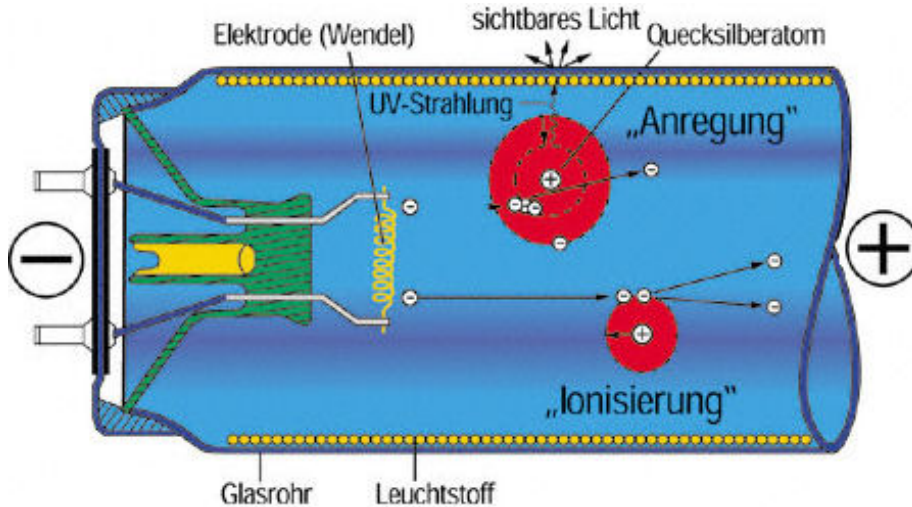

UV or black light lamp

Sketch of a mercury (low pressure) lamp
Excitation/ionisation of Hg by fast electrons
(Important Hg lines are 313 nm, 365 nm (i line),
405 nm (h line), 434 nm (g line), 546 nm (e line) and
577/579 nm und nm (orange double line)).

Electromagnetic radiation: Sources

X-rays



X-ray tube

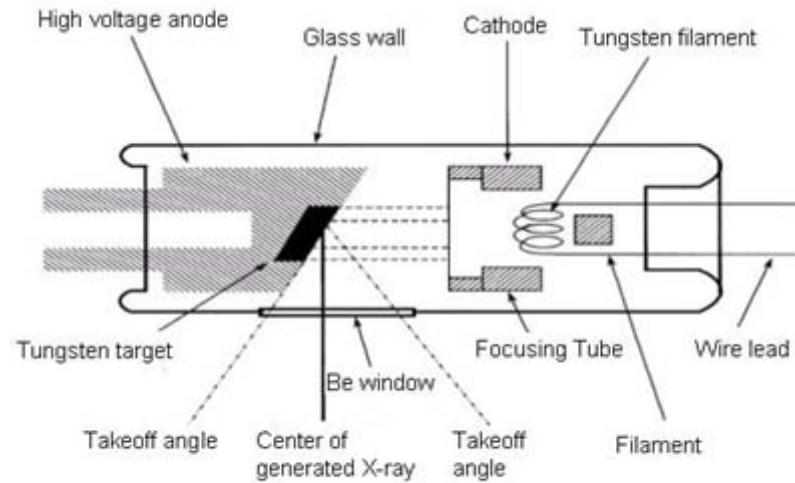

X-ray tube: sketched and dashed

Electromagnetic radiation: Sources

Synchrotron



Abb. 5: Die Leuchtdichte von DORIS im Vergleich zu einigen bekannten Strahlungsquellen. (Die Leuchtdichte ist die Zahl der Photonen, die pro Sekunde und Wellenlängenintervall in eine bestimmte Richtung abgestrahlt wird.)



tunable electromagnetic radiation

Electromagnetic radiation: Sources Synchrotron

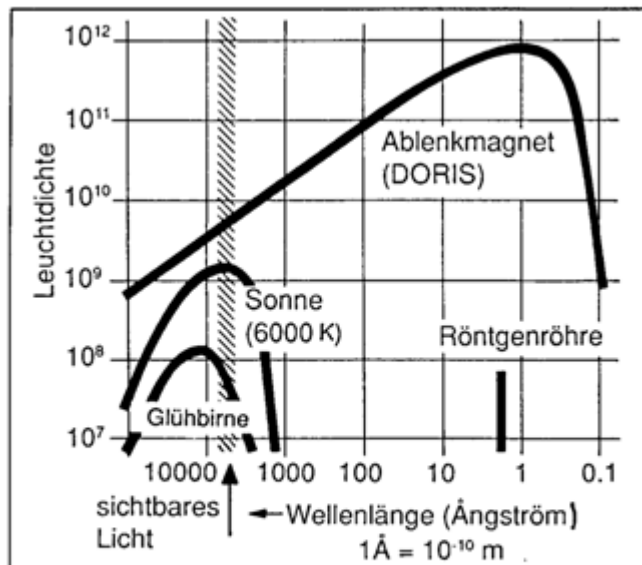
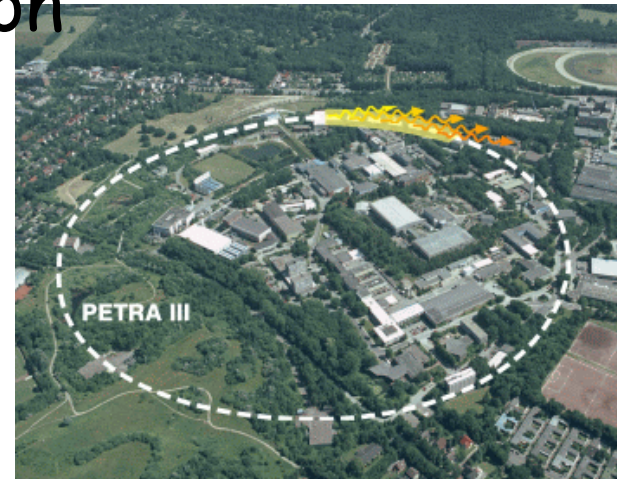
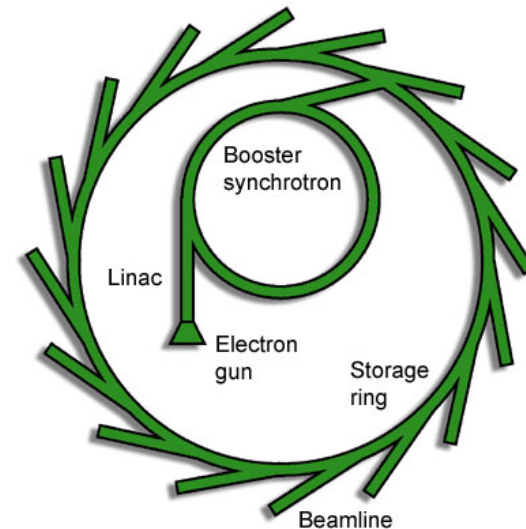
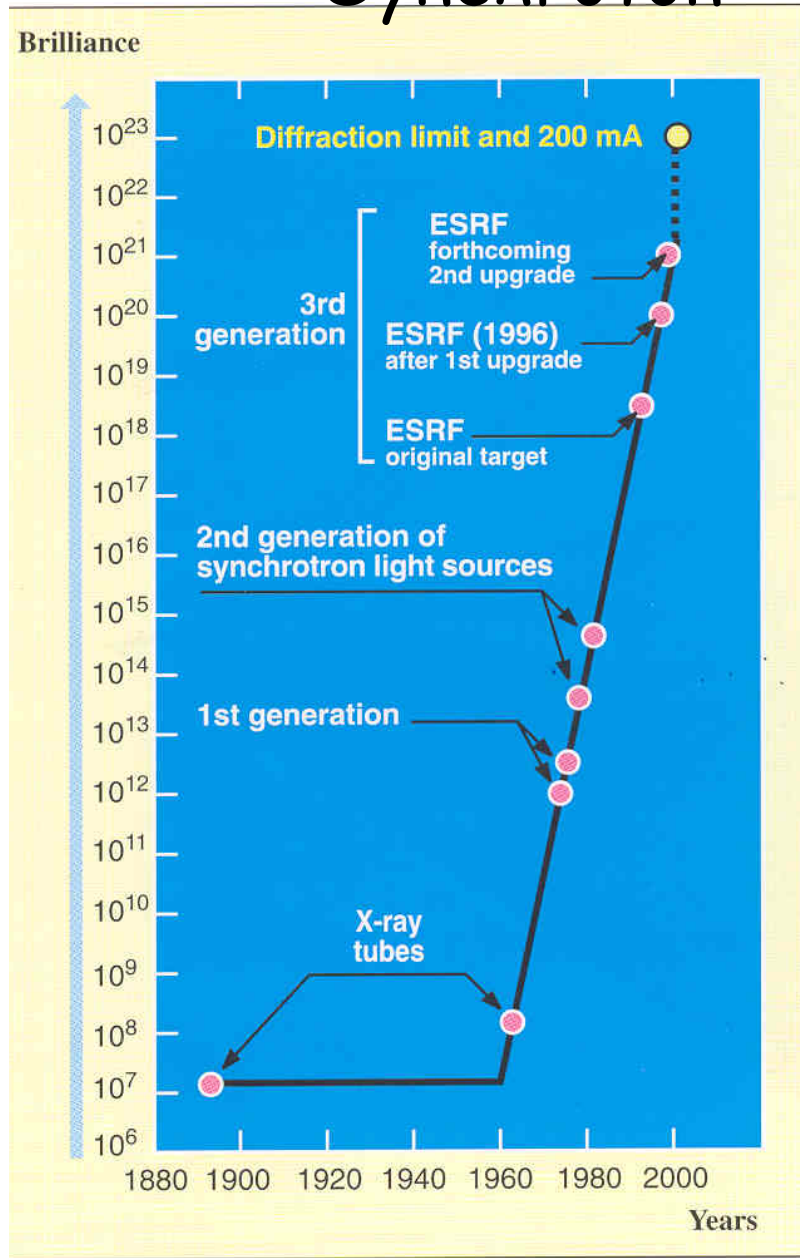

increase of
brilliance over the
years

Electromagnetic radiation: Sources Synchrotron

(range of tunability)

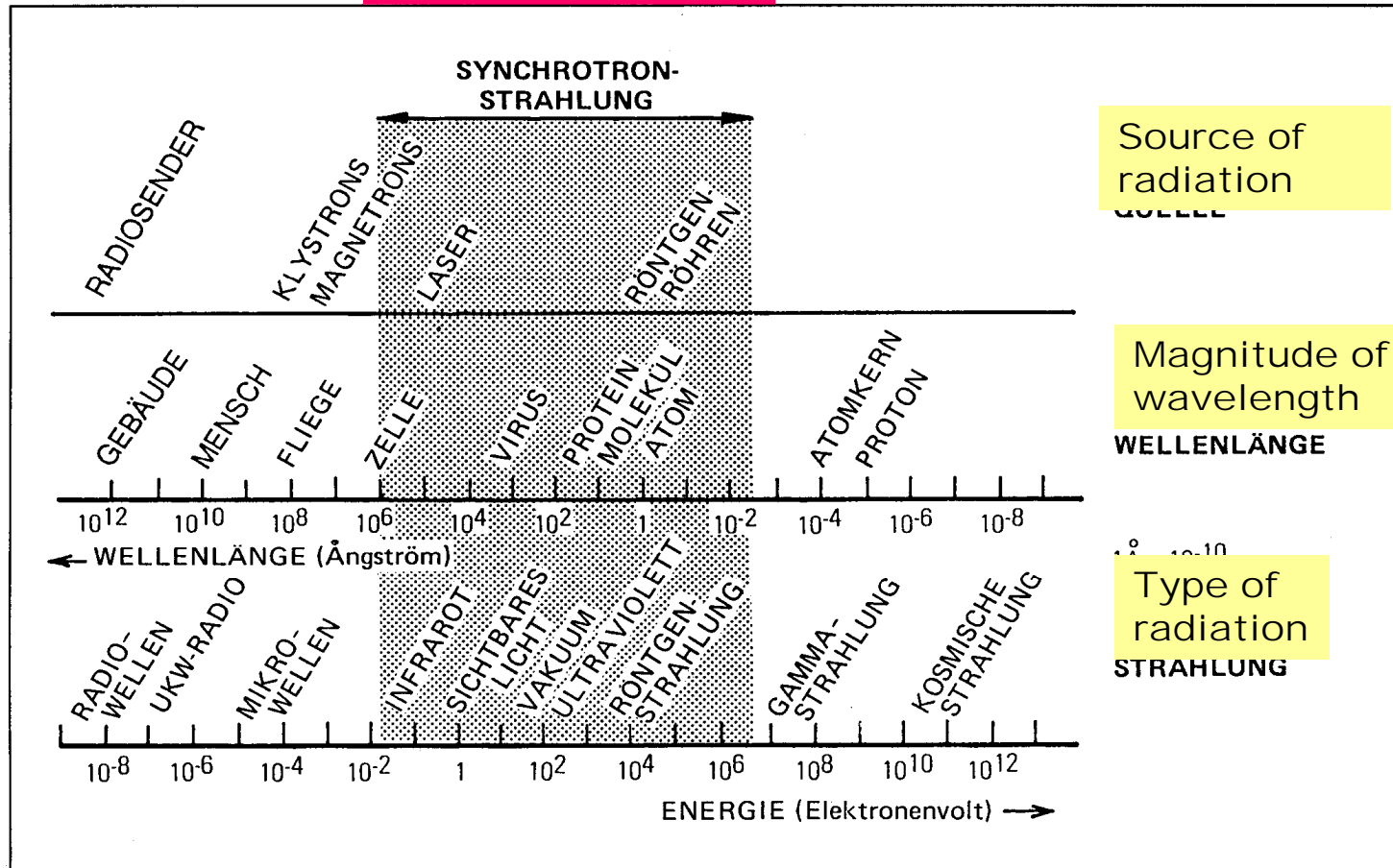

Use of Synchrotron Radiation in materials science

Electromagnetic radiation: Sources

Gamma-rays

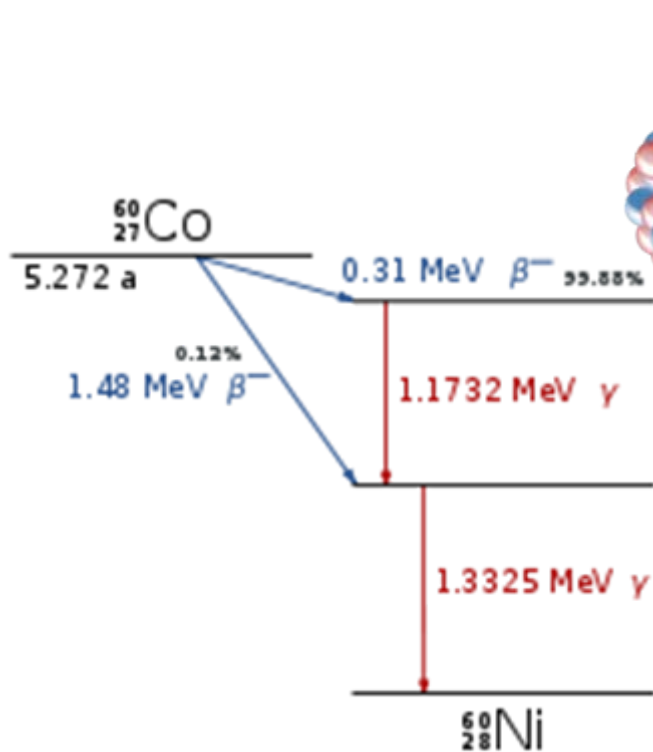

Decay scheme of ^{60}Co

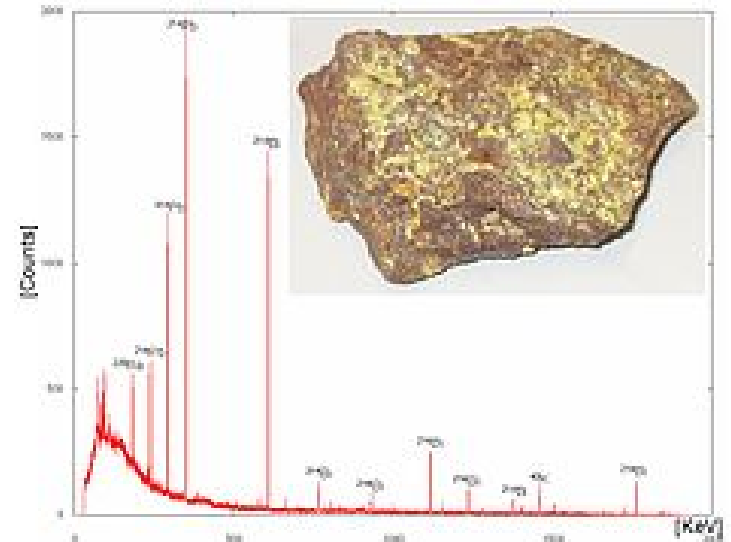
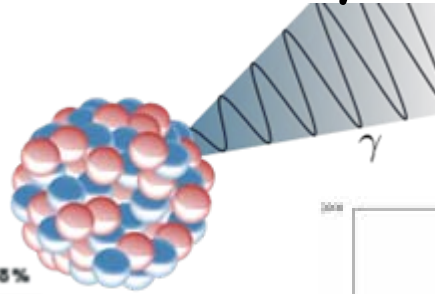

Gamma-ray spectrum of ^{238}U

Gamma rays can occur whenever charged particles pass through magnetic fields or pass within certain distances of each other or by nuclear reactions (e.g. fusion or decay processes)

Electromagnetic radiation: Sources

Gamma-rays



Gamma-radiation source

Penetrating Distances

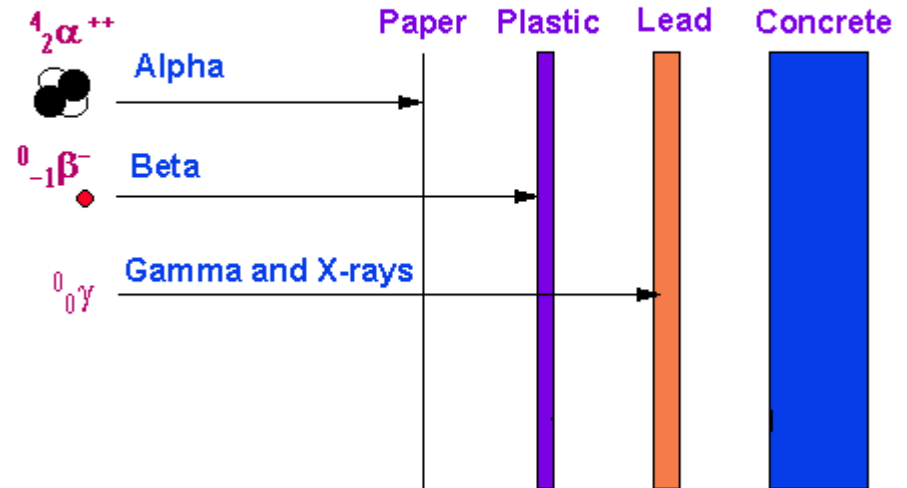

Nuclear decay products

Electromagnetic radiation: Sources

Neutrons

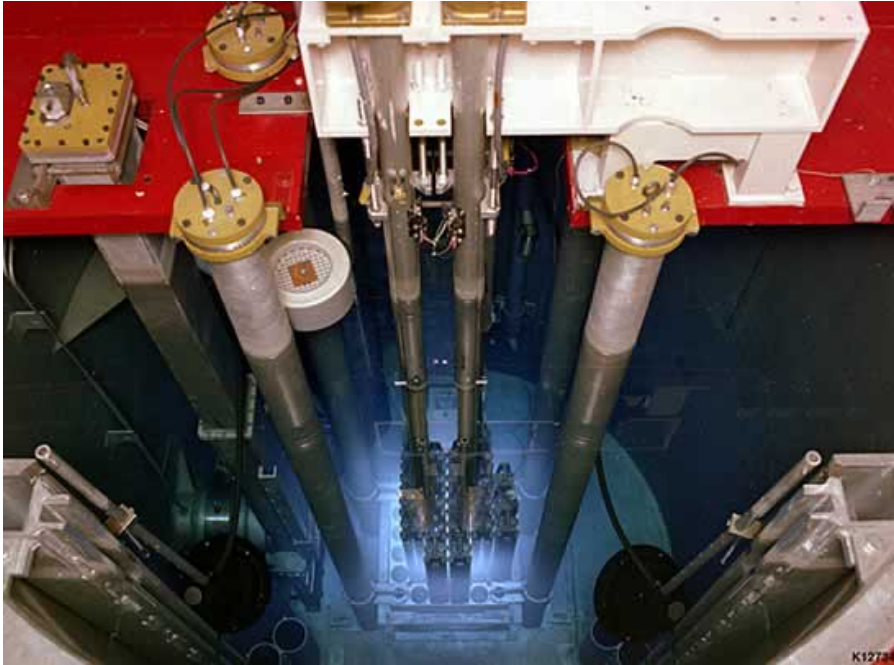

View into a nuclear reactor with Cherenkov radiation

Schematic of a Nuclear Power Plant

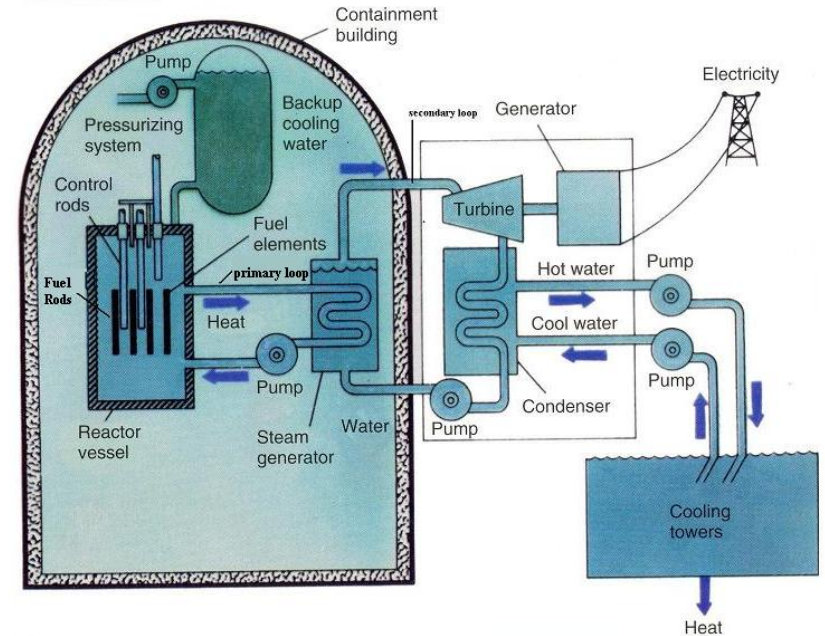

Sketch of a nuclear power plant

De Broglie wave length: $\lambda = h/(m \cdot v)$
e.g. n with $v = 3.300 \text{ m/s} \rightarrow 0,05 \text{ eV} \rightarrow 1,2 \text{ \AA} (0,12 \text{ nm})$