



University of Siegen - School of Science and Technology

Dept. of Civil Engineering – Chair of Geotechnical Engineering at the Research Institute for Water and Environment

Univ.-Prof. Dr.-Ing. habil. Kerstin Lesny



Alternative Energy Generation Solutions

Use of Wave Energy

Prof. Dr.-Ing. habil. Kerstin Lesny

DAAD Seminar, Panama, October 25-29, 2021



- Possible sources of ocean energy
- Tidal energy converting systems
- Wave energy converting systems
- Joint research project NEMOS
- Helical anchors for mooring floating devices
- Conclusions & Outlook

Possible sources of ocean energy

Wave energy:

Converters harvest the energy in ocean waves. Available technologies include oscillating water columns, oscillating body and overtopping converters.

Tidal energy:

Converters harvest the energy due to tides. Options are tidal-range technologies, tidal-current or tidal-stream converters.

Salinity gradient energy:

Resulting from differing salt concentrations. Existing projects are based on "pressure retarded osmosis", with freshwater flowing through a membrane to increase the pressure in a tank of saltwater or on "reverse electro dialysis" with ions of salt passing through alternating tanks of salt- and freshwater.

Ocean thermal energy conversion: Generates power from the temperature difference between warm surface seawater and cold seawater at 800–1,000 metres depth.

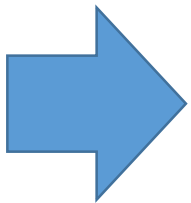

Most of the projects only operated at a research or development stage and have not reached commercial applications!



Possible sources of ocean energy

Installed capacity ocean energy:

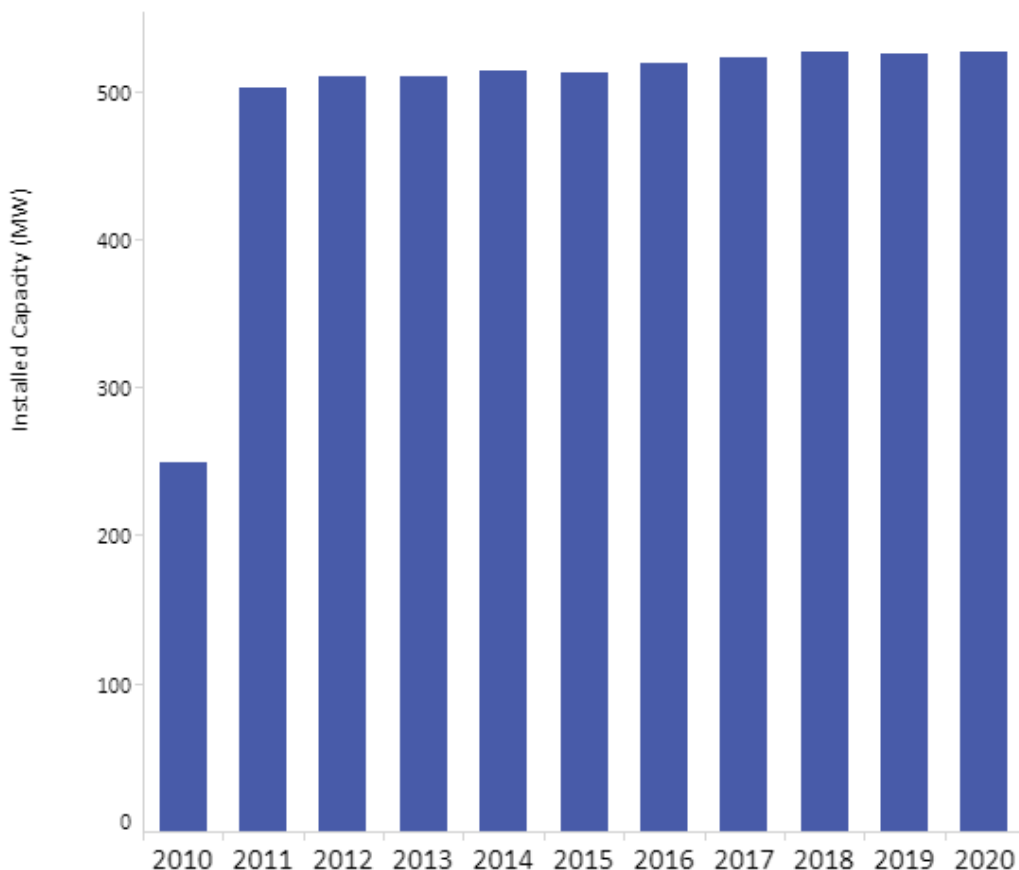

©IRENA Visit www.irena.org/Statistics for more information

Installed capacity offshore wind energy:

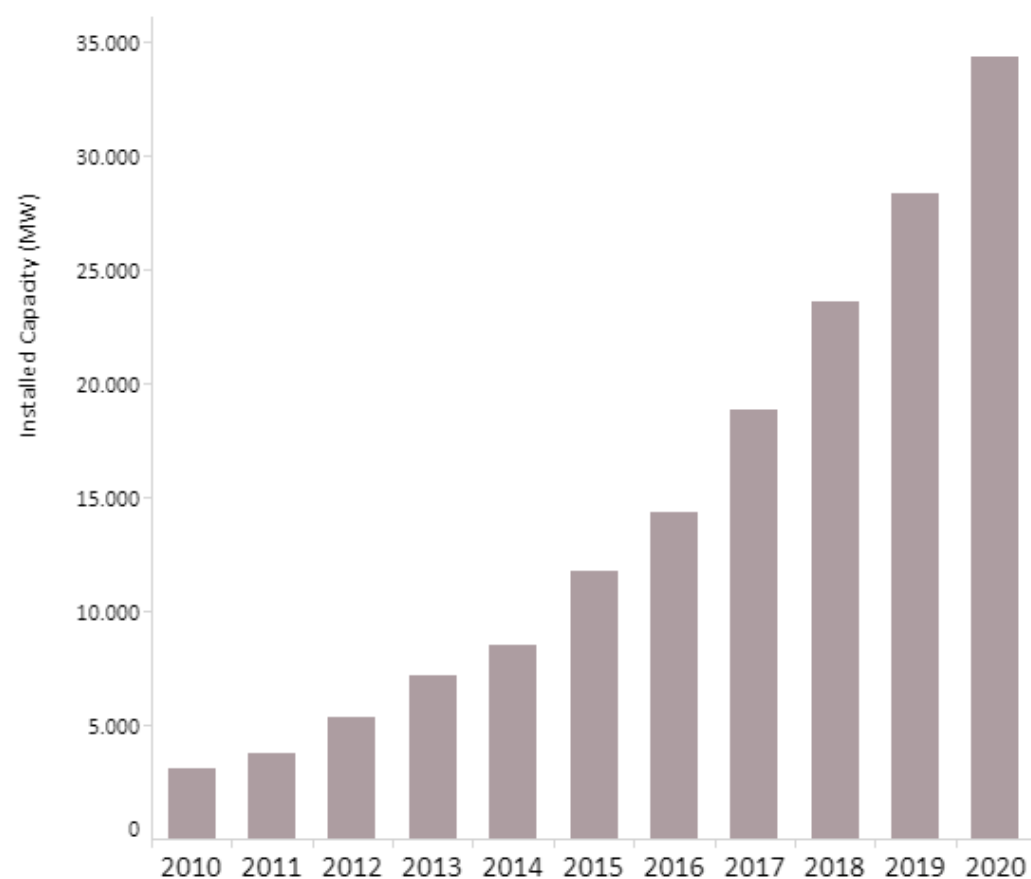

©IRENA Visit www.irena.org/Statistics for more information

(International Renewable Energy Agency: <https://www.irena.org/ocean>)



Tidal energy converting systems

Tidal energy:

- tidal range
- tidal currents

World map of M2 tidal amplitude (NASA)

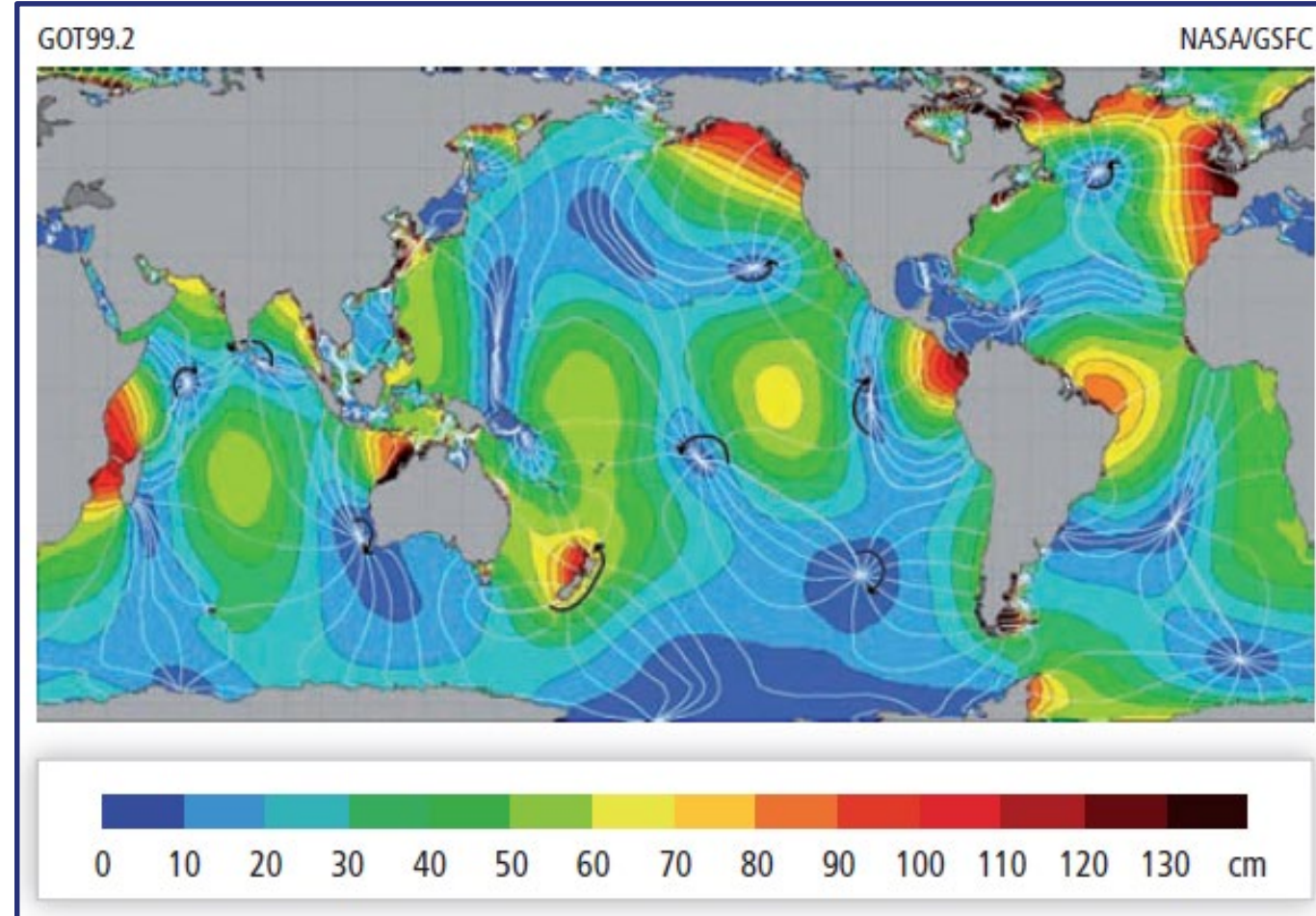

(IPCC report (2011) „Renewable Energy Sources and Climate Change Mitigation, chapter 6: Ocean Energy“)

Tidal energy converting systems

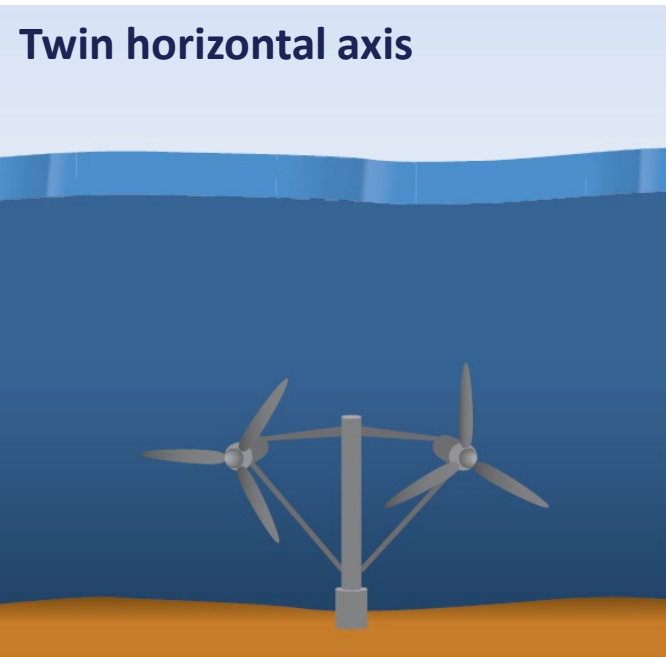
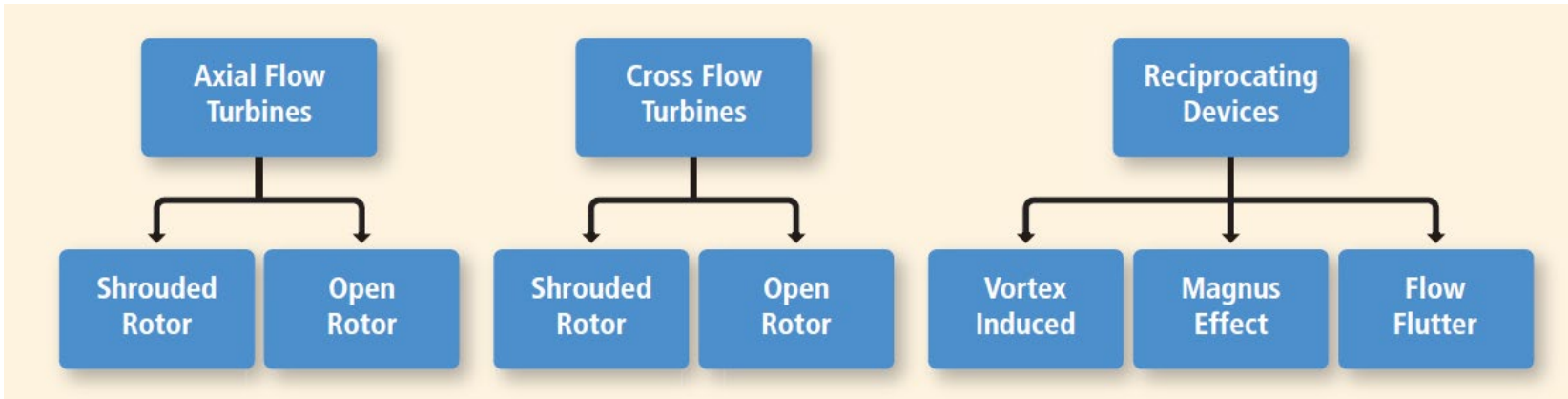

Twin horizontal axis

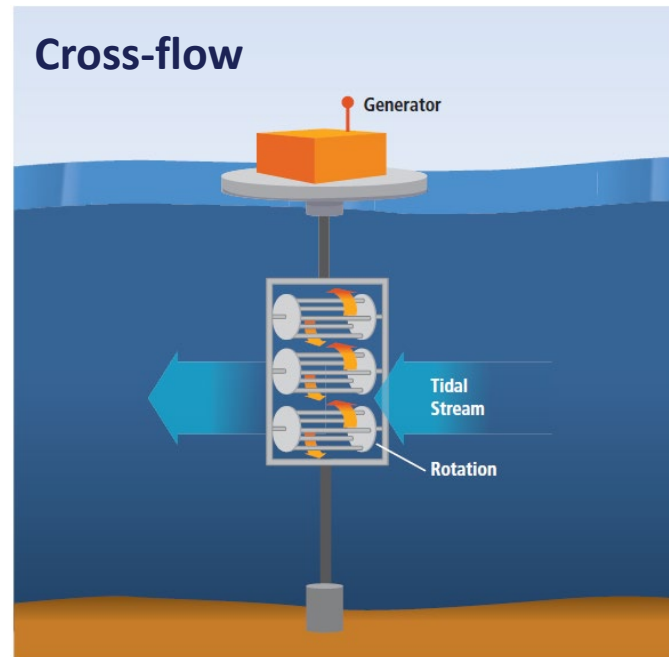

Cross-flow

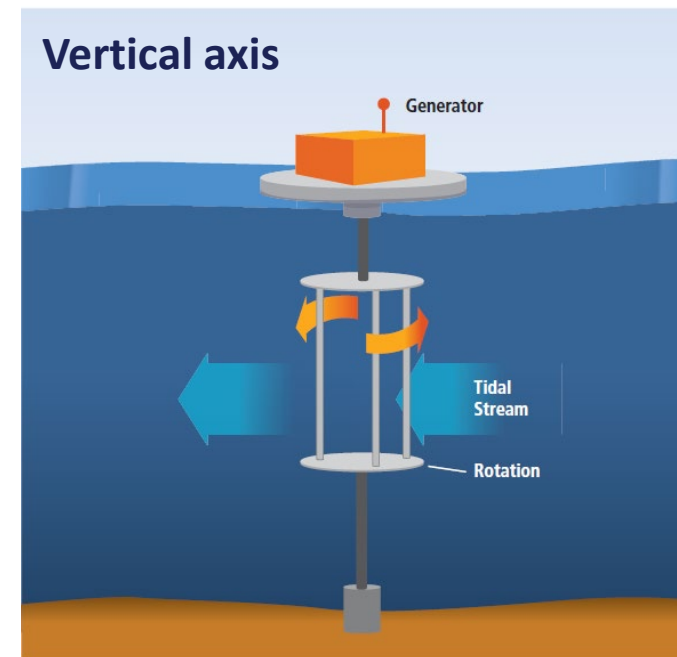

Vertical axis

(IPCC report (2011) „Renewable Energy Sources and Climate Change Mitigation, chapter 6: Ocean Energy“)



Tidal energy converting systems

Seagen

- Commissioned 2008 in Strangford Lough, Northern Ireland.
- Rated capacity of 1.2 MW from two 600 KW turbines.
- Total investment of £ 12 Mio.
- During operation production of up to 5GW/h equal to the power required by 1,500 households annually.
- In total over 11.6 GWh of power during its life cycle.
- Successfully decommissioned in July 2019.

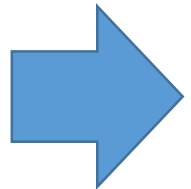

**One of the very few projects
suitable for commercial use!**

(<https://www.power-technology.com/projects/strangford-lough/>)

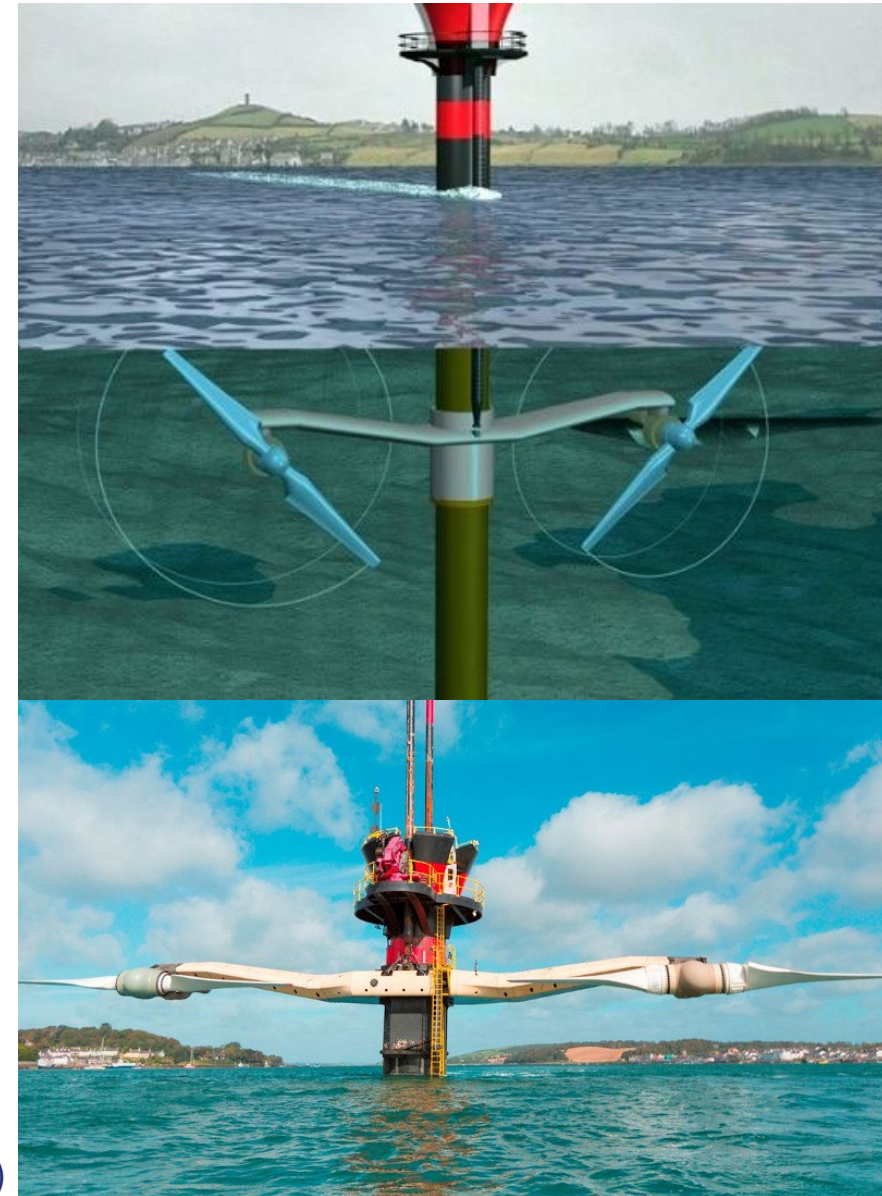

Wave energy converting systems

Global offshore annual wave power level distribution

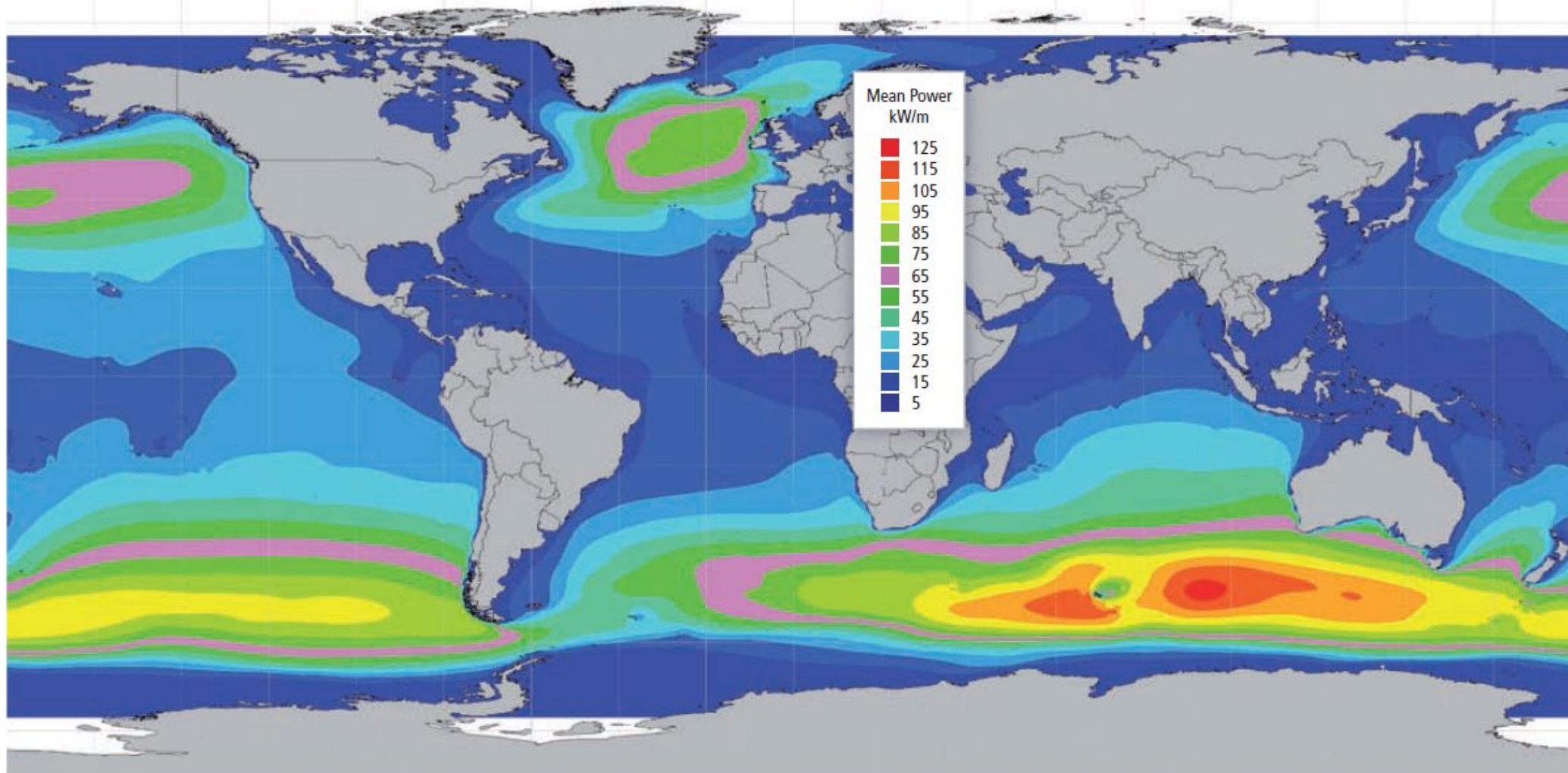

(IPCC report (2011) „Renewable Energy Sources and Climate Change Mitigation, chapter 6: Ocean Energy“)



Wave energy converting systems

Regional theoretical potential of wave energy

REGION	Wave Energy TWh/yr (EJ/yr)
Western and Northern Europe	2,800 (10.1)
Mediterranean Sea and Atlantic Archipelagos (Azores, Cape Verde, Canaries)	1,300 (4.7)
North America and Greenland	4,000 (14.4)
Central America	1,500 (5.4)
South America	4,600 (16.6)
Africa	3,500 (12.6)
Asia	6,200 (22.3)
Australia, New Zealand and Pacific Islands	5,600 (20.2)
TOTAL	29,500 (106.2)

Only areas where theoretical wave power $P \geq 5 \text{ kW/m}$ and latitude $\leq 66.5^\circ$

(IPCC report (2011) „Renewable Energy Sources and Climate Change Mitigation, chapter 6: Ocean Energy“)



Wave energy converting systems

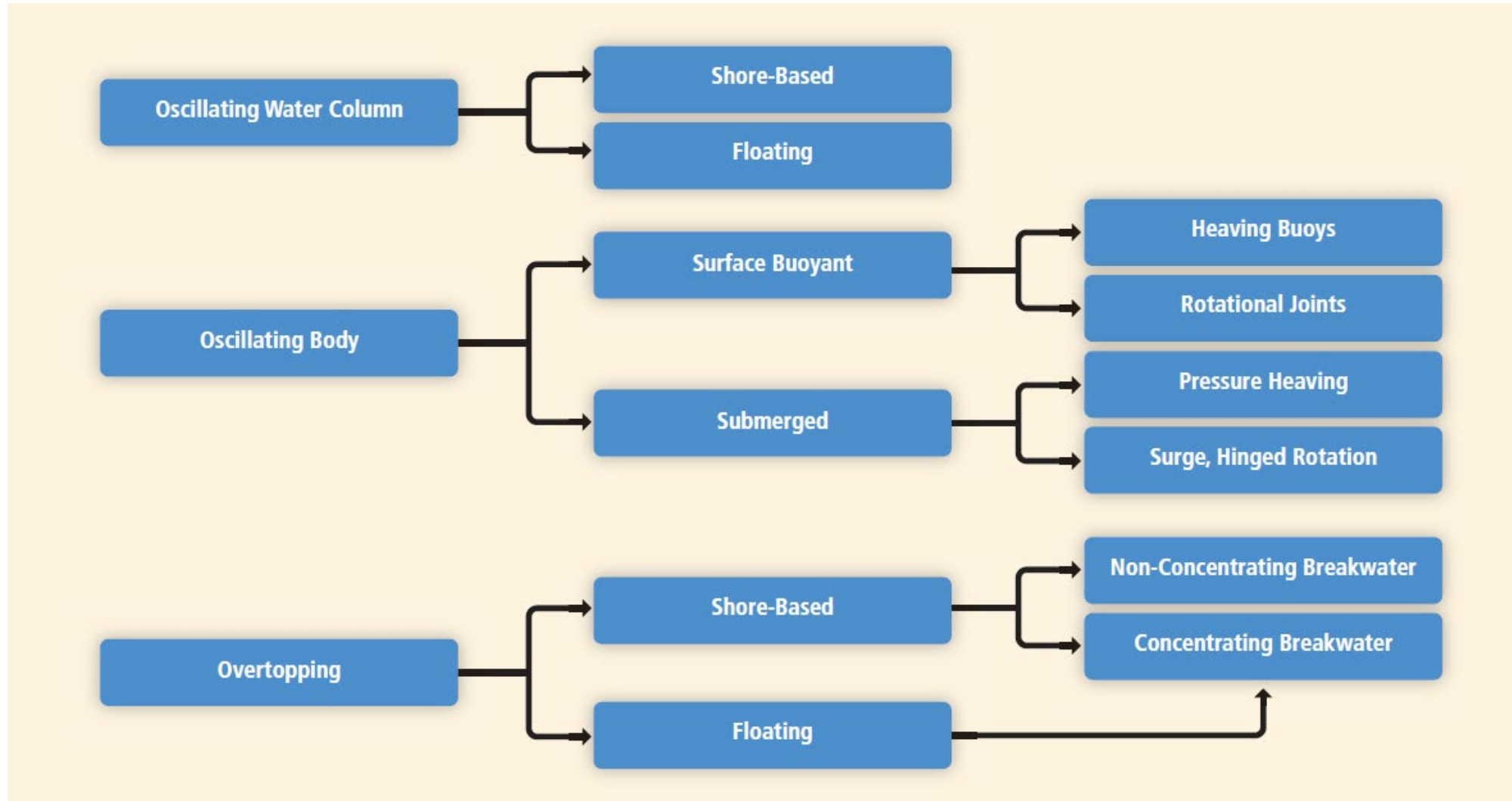

(IPCC report (2011) „Renewable Energy Sources and Climate Change Mitigation, chapter 6: Ocean Energy“)

Wave energy converting systems

Oscillation water column

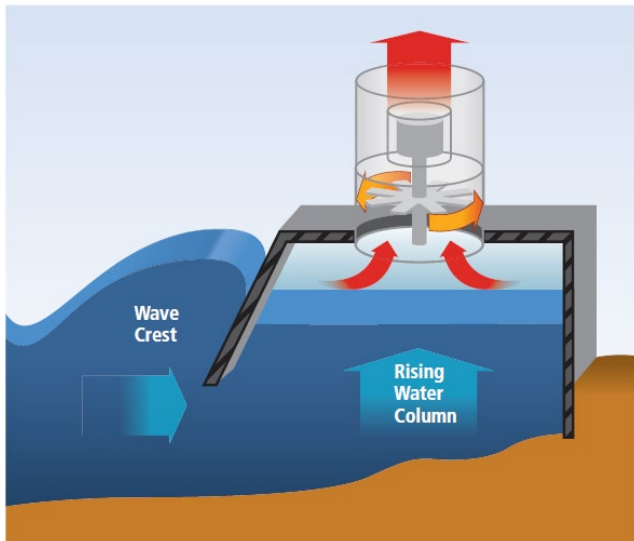
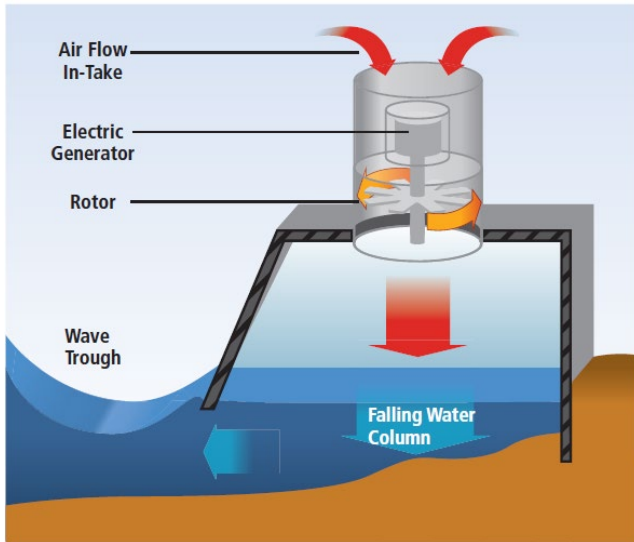

Oscillation body

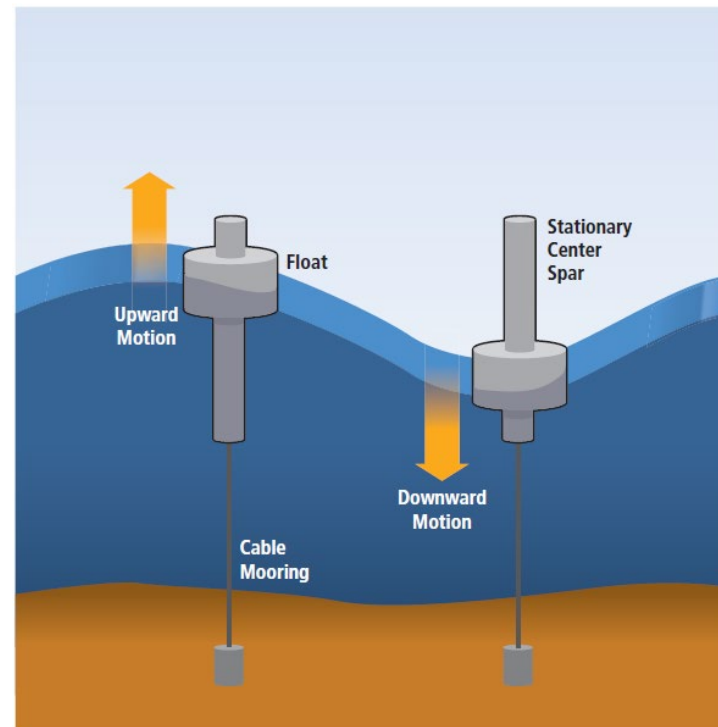

Overtopping

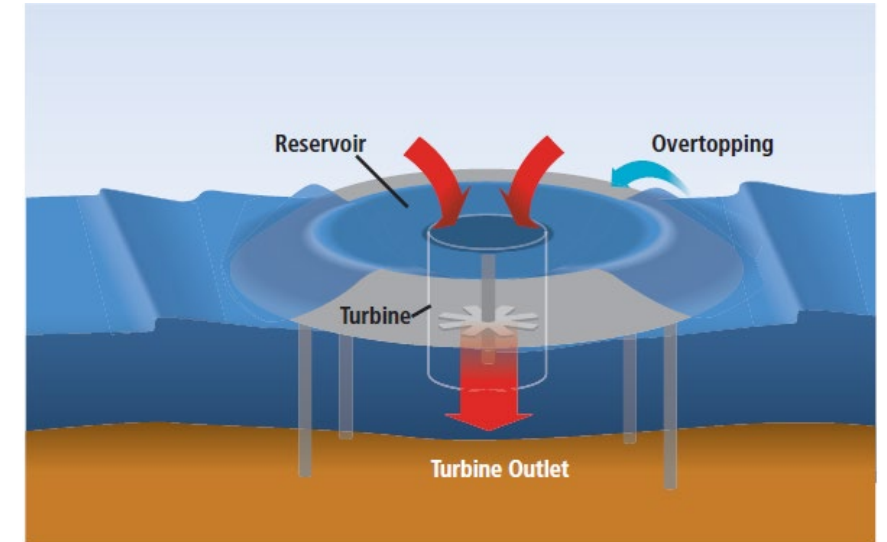

(IPCC report (2011) „Renewable Energy Sources and Climate Change Mitigation, chapter 6: Ocean Energy“)



Wave energy converting systems

Pelamis

- Attenuator device.
- Agucadoura Wave Farm world's first commercial wave energy project; located 5km off the Agucadoura coast in Portugal.
- Commissioning 2008, technical problems only after four months of use and tought back to land; plant was never be re-installed.
- A second-generation device, P2-001, was ordered by E.ON UK in 2009 and tested in 2010; another device, P2-002, was deployed by ScottishPower in May 2012.
- P2-001 device decommissioned in April 2016; P2-002 device decommissioned in 2016.

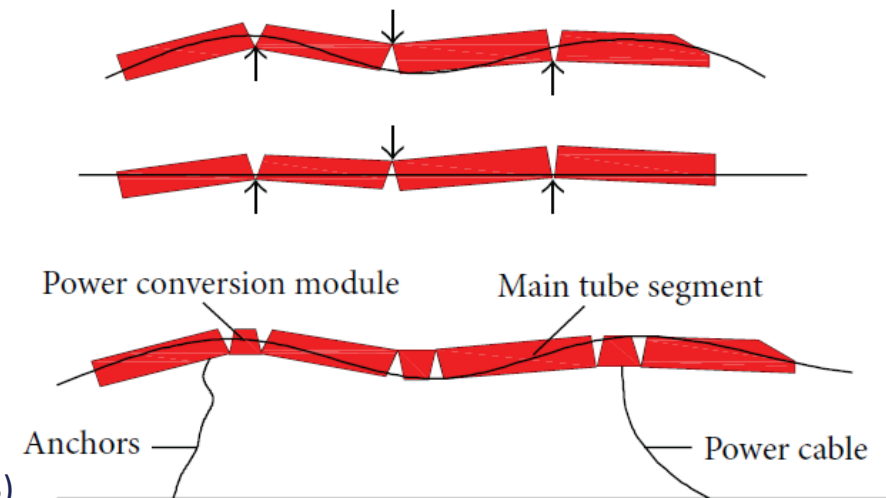

(He et al., 2013)



Wave energy converting systems

Mutriku wave energy plant

- Oscillating water column device.
- Located in Mutriku harbour, Bay of Biscay, Spain.
- Comissioned in 2011; still in operation.
- 16 Wells turbines with a total rated power of 300 kW integrated in an existing breakwater.
- Since 2019 part of Biscay Marine Energy Platform (BiMEP) and available as research and test site.

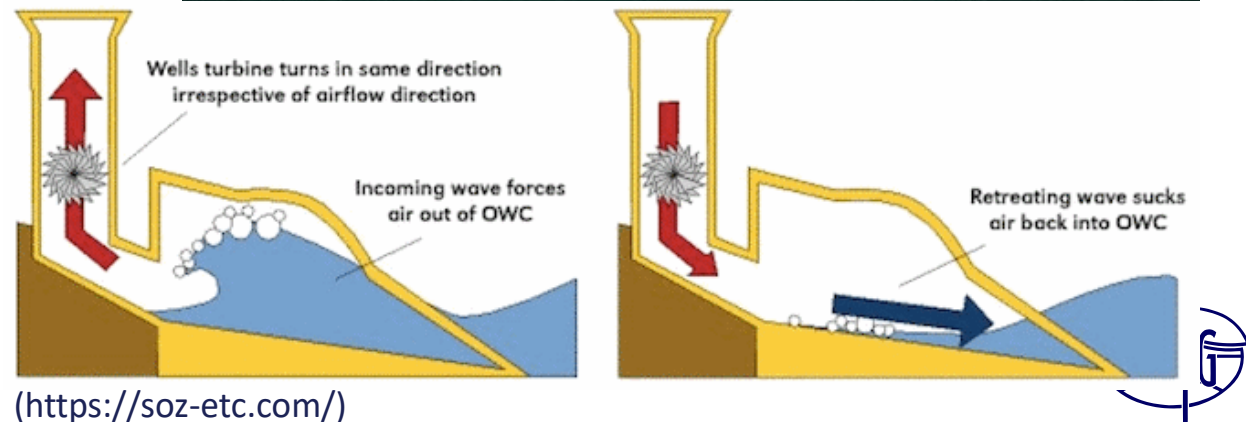

Wave energy converting systems

High investment and high maintenance costs, i.e. most devices only reached prototype status

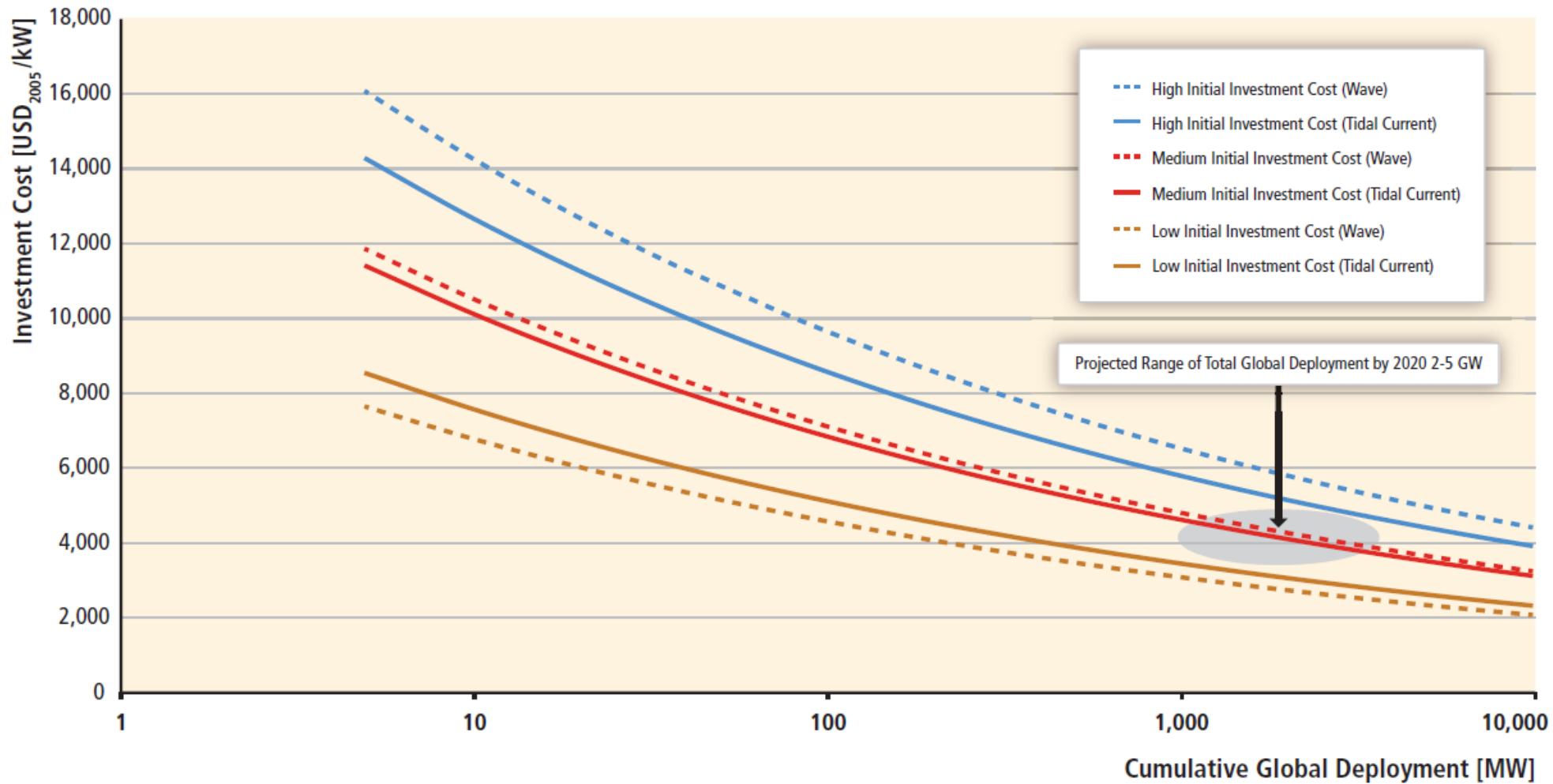

(IPCC report (2011) „Renewable Energy Sources and Climate Change Mitigation, chapter 6: Ocean Energy“)



Joint Research project NEMOS

- Joint research project aimed at developing a prototype of the NEMOS wave energy converter
- Project partners:

NEMOS (Leader), DST (wave tank etc.), UDE/HCU (foundation), Schaeffler (pulleys), Liros (ropes)

History:

2010: Tank tests in research facilities

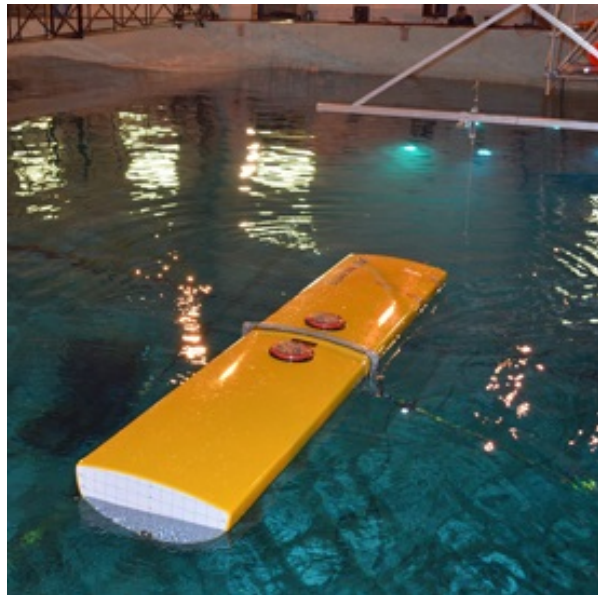

2013: Scaled tests in nearshore environment

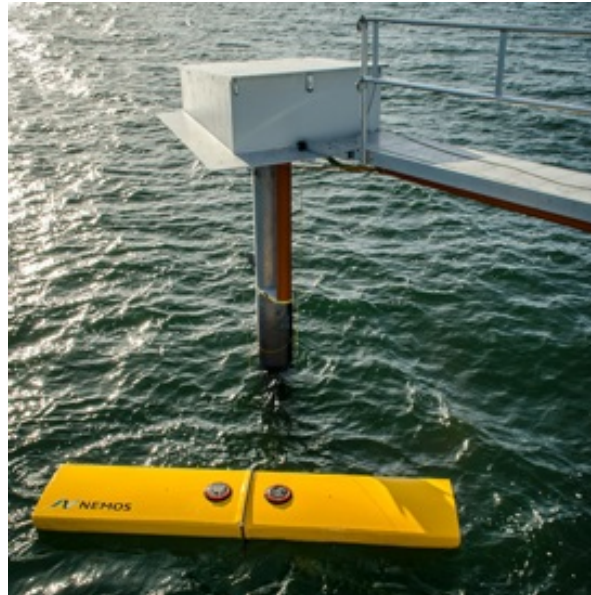

2016: Full scale power take-off tests



2019: Large scale offshore installation



(all: Nemos)



Joint Research project NEMOS

Sub-project: NEMOS-Foundation

- Developing suitable mooring systems.
- Consultancy on site selection, and site investigations.
- Analysis of possible foundation solutions.
- Research on suitability of helical anchors as mooring alternative.
- Performance of scale model tests on helical anchors in saturated sand under monotonous and cyclic loading.

Initial Concept of NEMOS Wave Energy Converter

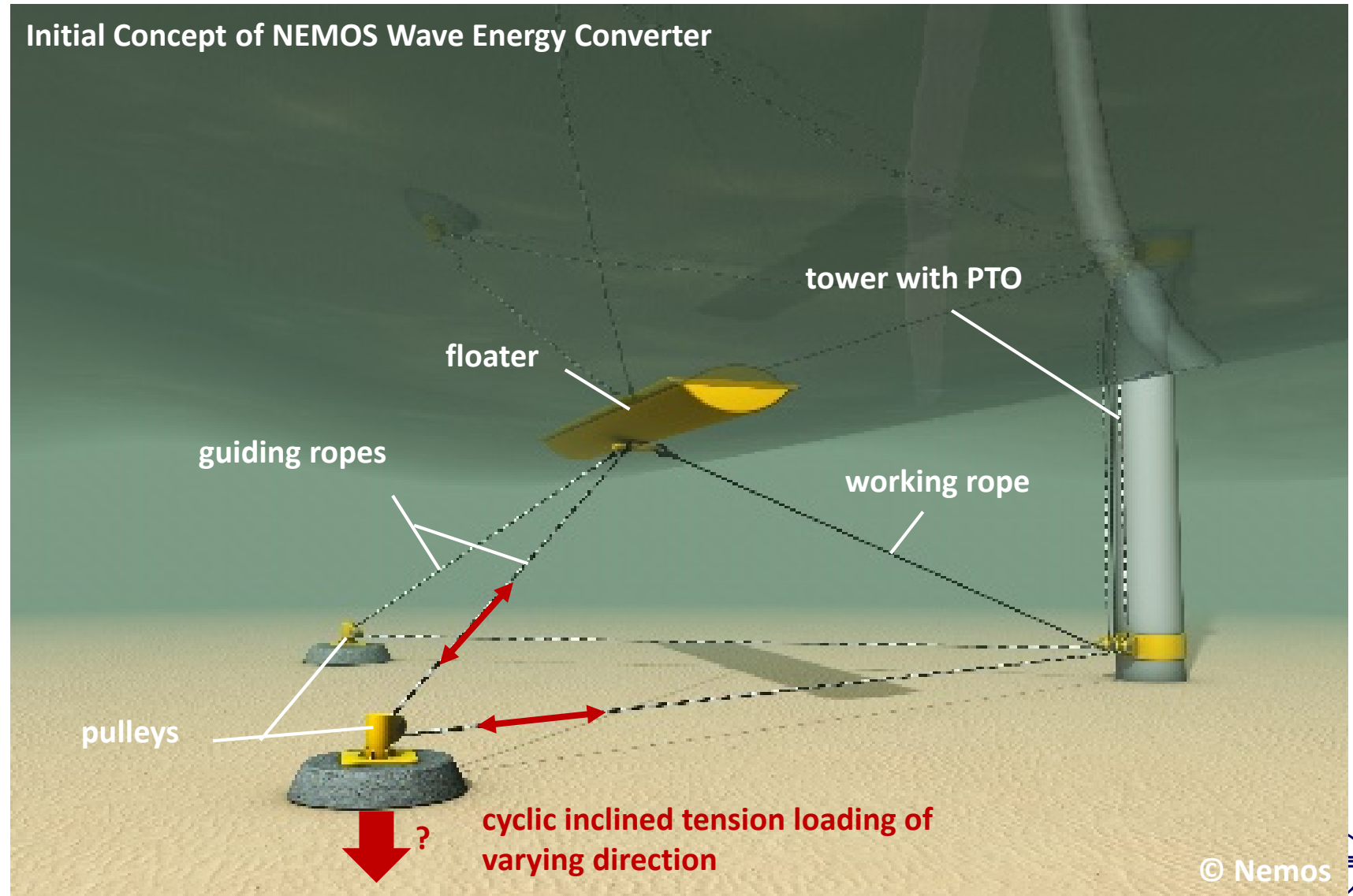

Alternative foundation solutions:

- Analysis of frame structure with shallow steel plate foundations with skirts and ballast tanks:

Top view:

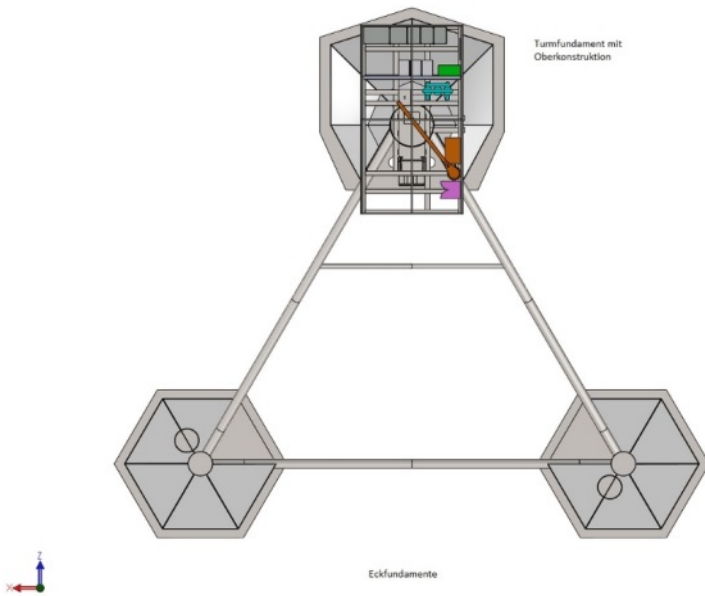

System & loading:

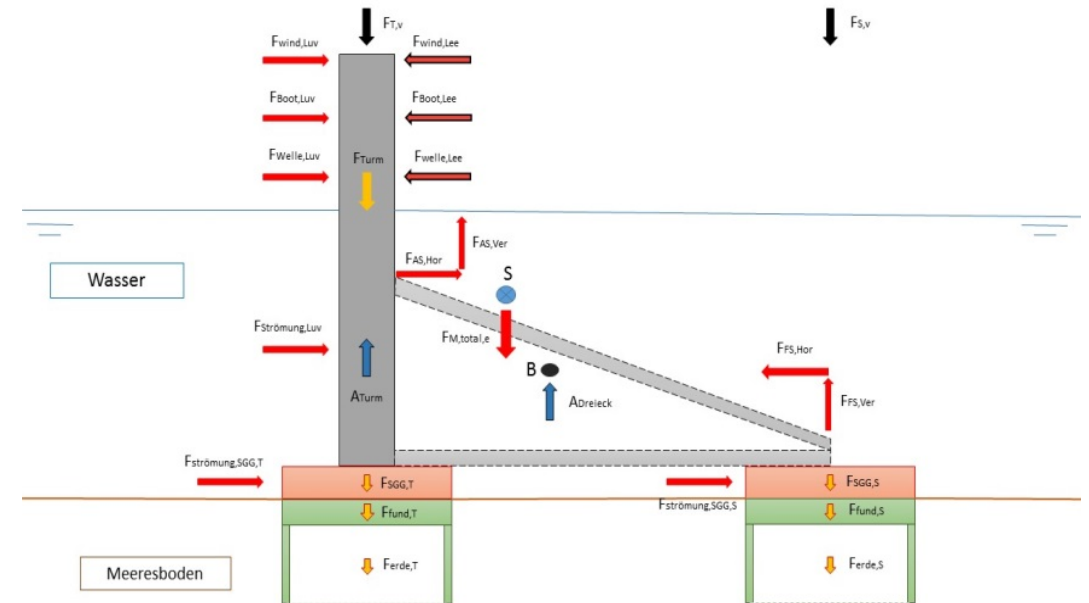

- At a later stage substitution of ballast tanks and skirts by helical anchors as fixation elements including a pre-stressing arrangement based on a spring system for pre-stress adjustment.

Shallow plate foundations:

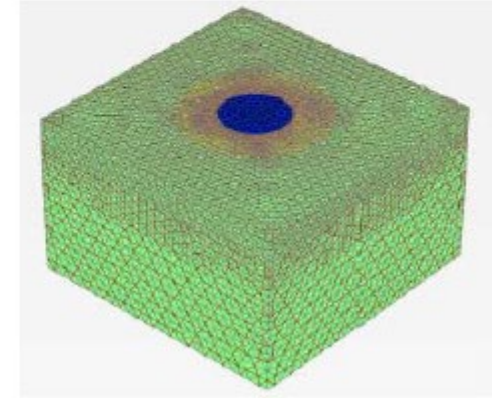
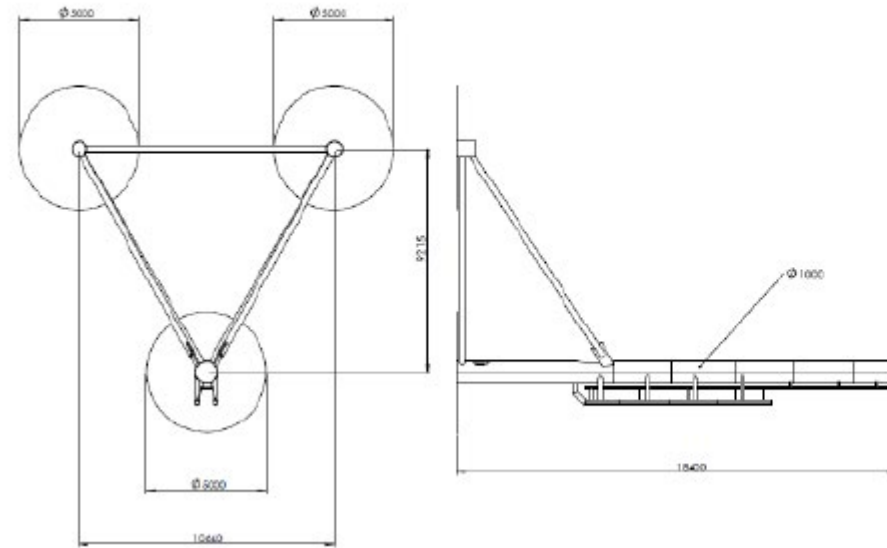

Shallow beam foundation:

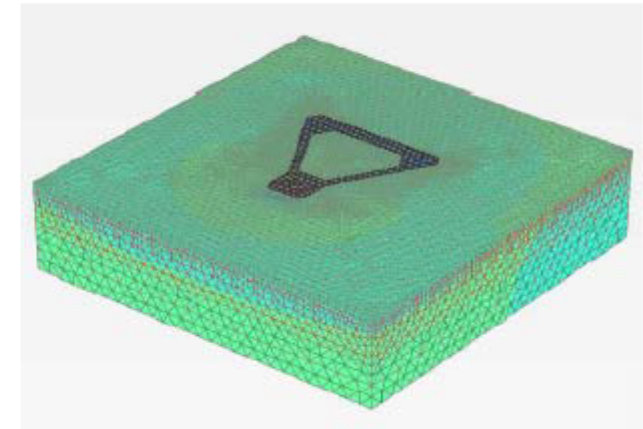
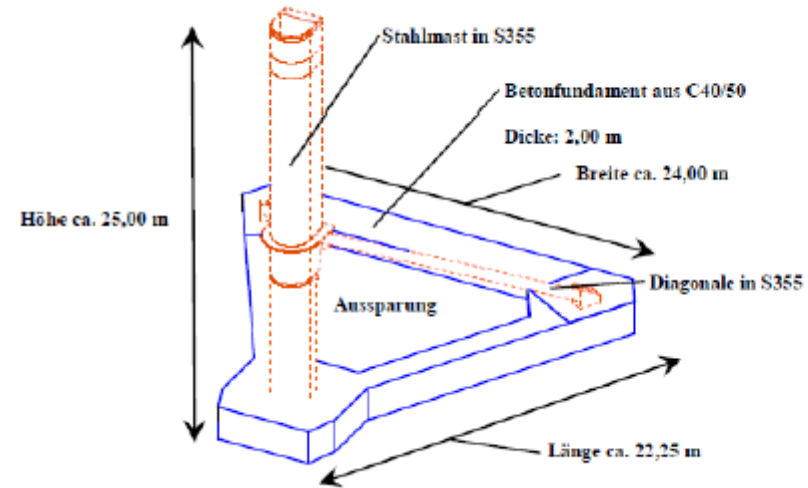

Results of numerical analysis:

- Arrows indicate direction of wave attack.
- Overall sufficient stability in all investigated load cases.
- Foundation solution feasible.
- Tension stresses in parts of foundation base critical.
- Skirts to prevent scour and sufficient ballasting required.

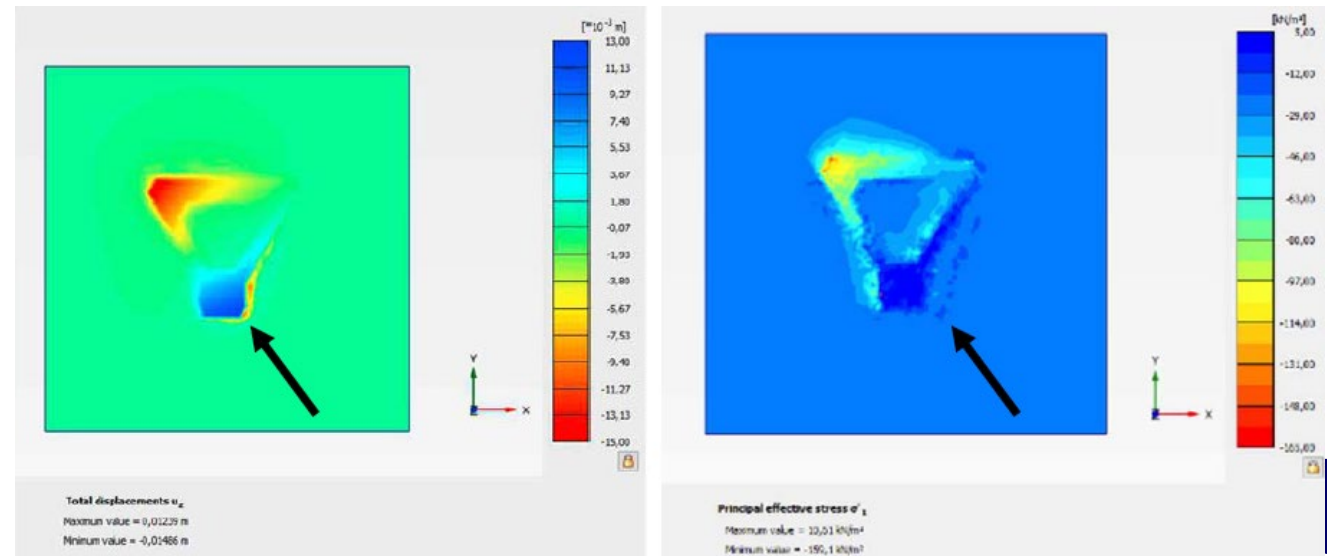
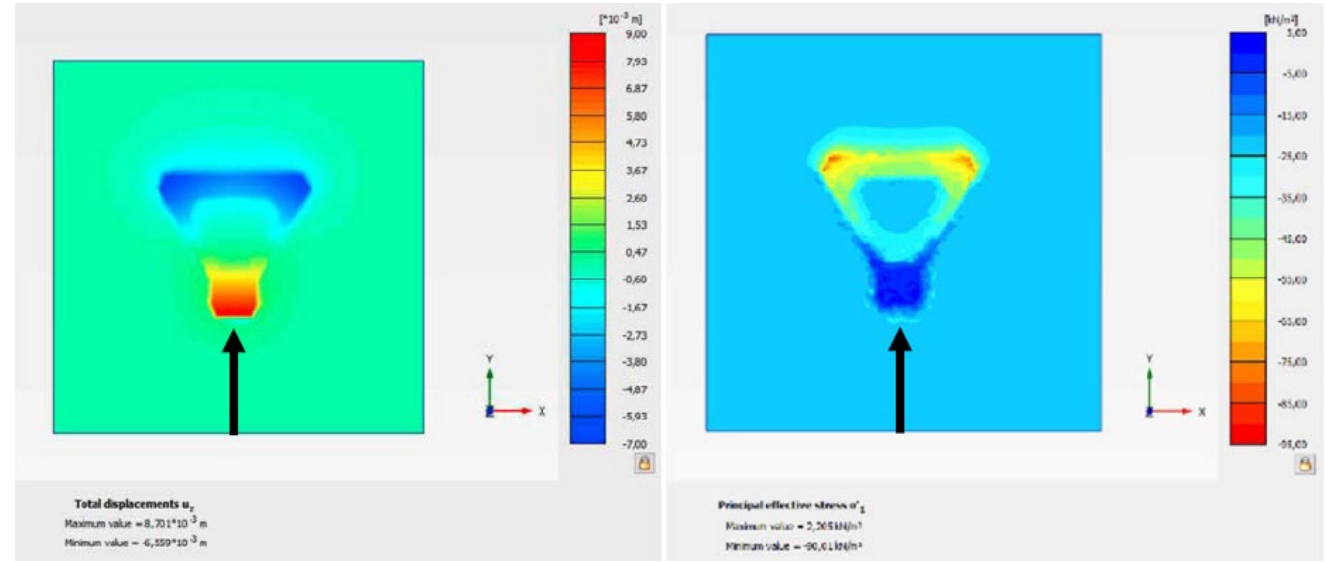

Helical anchors as foundation alternative?

First use: Maplin Sands Lighthouse, England, 1838 by Alexander Mitchell

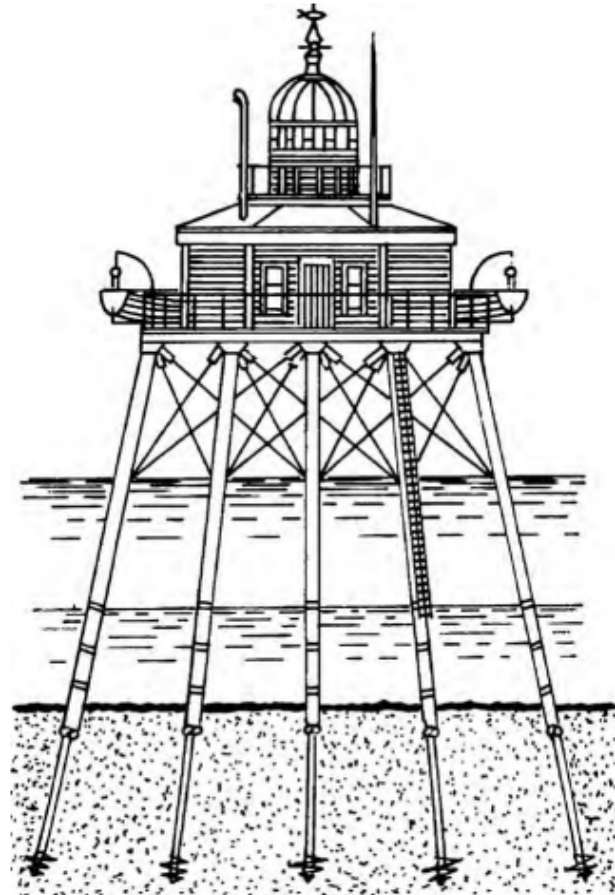

onshore use:

Utility poles, masts,
small wind turbines etc.

offshore use:

Pipelines, bridge piers,
bouys etc.

(Perko, 2009)

Helical anchors as mooring alternative?

Advantages:

- Increased pullout capacity by additional helical plate compared to pile of similar shaft geometry.
- Ecologically friendly → low noise emissions compared to typical offshore pile installation by driving which requires application of e.g. bubble curtains to avoid disturbance and harm of sea mammals.
- Economically attractive → reduced material consumption, reuse possible.
- Decommissioning/removal possible by applying opposite installation procedure.

Disadvantages:

- Installation under water in harsh offshore environments far offshore.
- Installation requires sufficient ground conditions (e.g. no boulders) and equipment (compression and torsion).
- Cyclic loading behaviour critical (only tension loading) and relatively unknown.

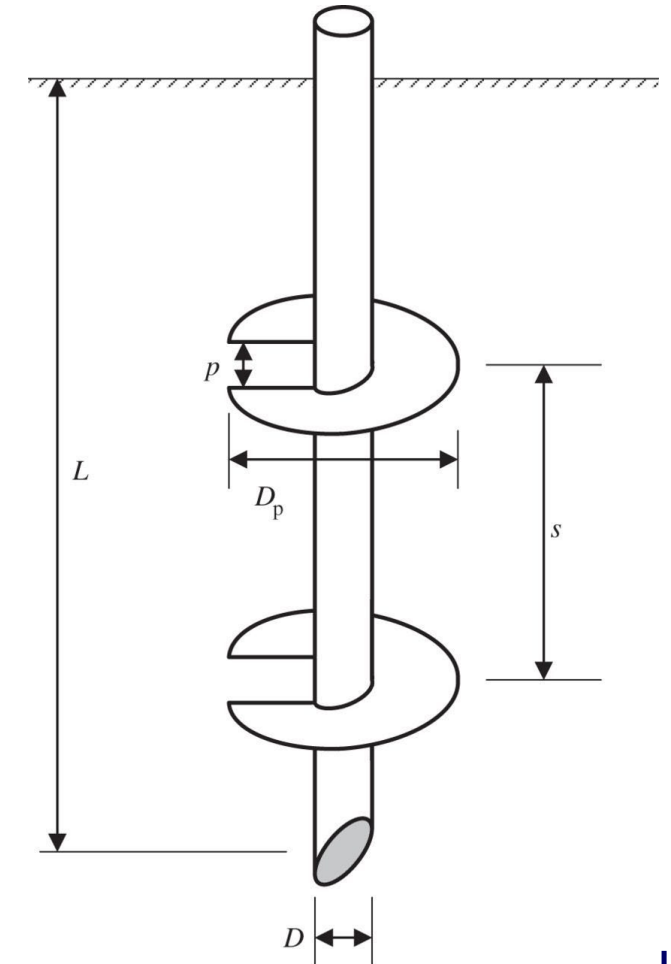

(Byrne & Houlsby, 2015)



Helical anchors for mooring floating devices

Scale Model Tests on Helical Piles – Experimental Setup

Test tank:

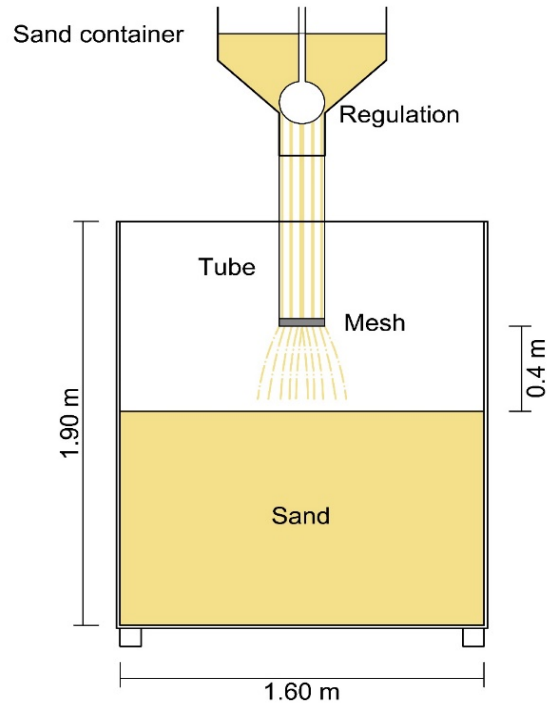

Loading Arrangement:

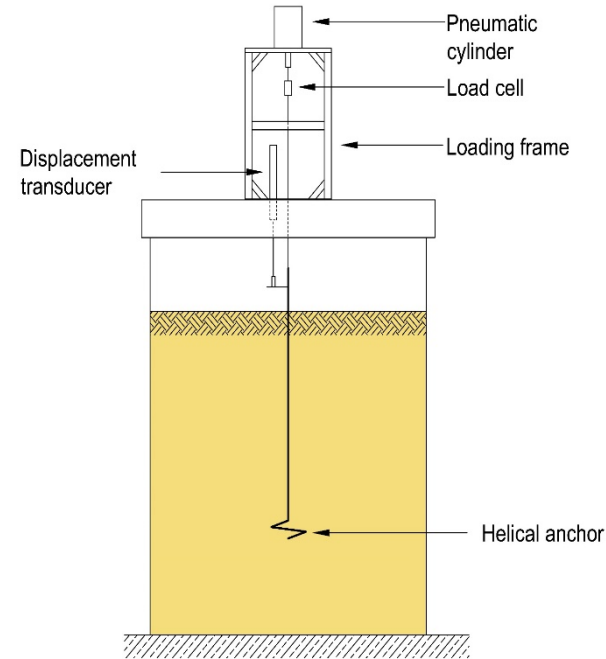

Model anchors:



- Test soil: medium to coarse dense sand, saturated after pluviation
- Model anchors: Helix \varnothing 10/12/15/20 cm, shaft \varnothing 3 cm, closed-ended, model scale \sim 1:8, either placed during sand pluviation or screwed in after pluviation with very low rotation speed; constant embedment depth of 1.0 m.

Helical anchors for mooring floating devices

Monotonous Pullout Tests

- Tests conducted displacement-controlled with lowest possible speed of 20 mm/s of available indoor crane.
- Pullout capacity Q_u determined from peak of load-displacement curve.
- No significant effects from installation procedure (placed (p) or screwed in (s)).

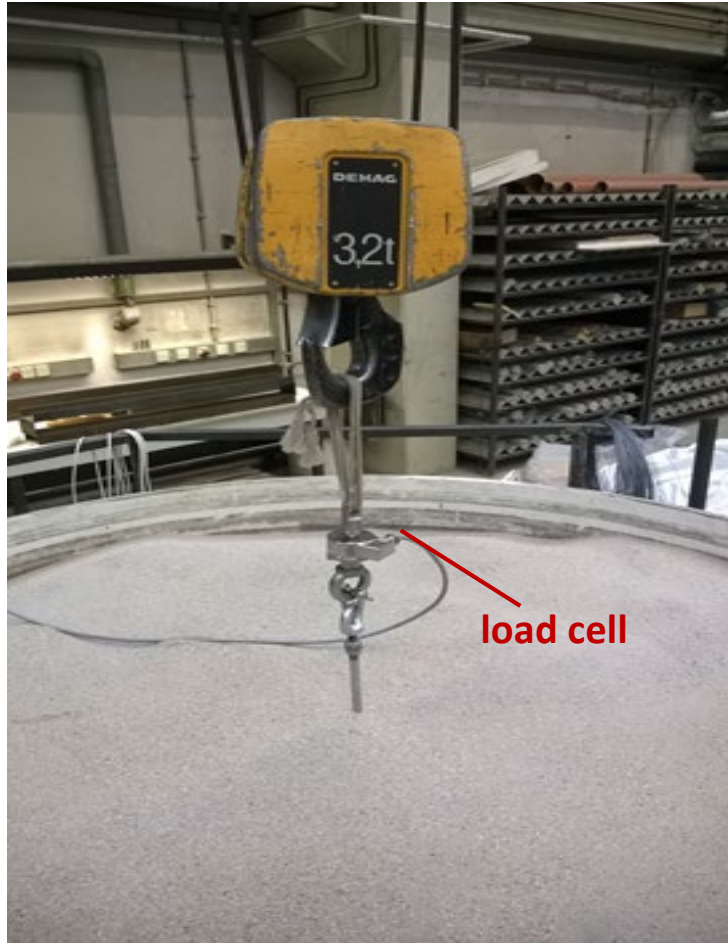

Test results:

Anchor No. & Installation type	Helix diameter D [mm]	H/D [-]	$Q_{u,mean}$ [kN]
S4-1p, S4-2s, S4-3s, S4-4s, S4-5p, S4-6p, S4-7s	100	10	9.18
S5-1p, S5-2p, S5-3p	120	8.3	12.55
S6-1p, S6-2p, S6-3p	150	6.7	17.80
S7-1p, S7-2p, S7-3p	200	5	22.93



Helical anchors for mooring floating devices

Analysis of Dimensionless Pullout Capacity N_{qu}

Comparison with other tests results:

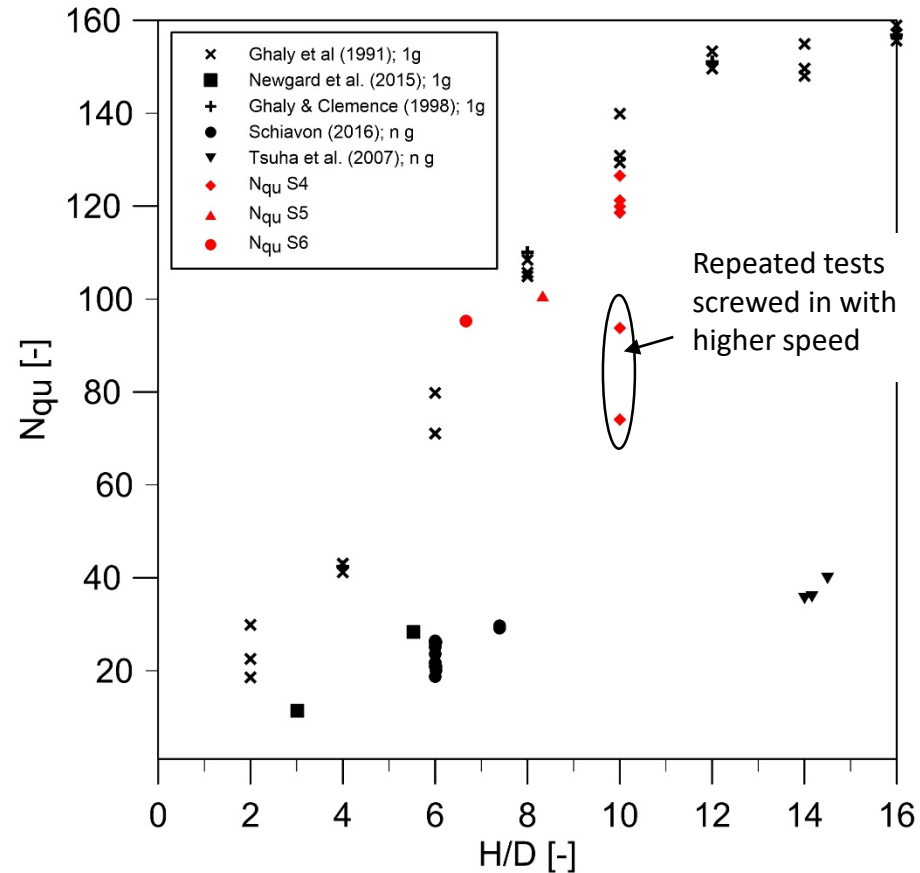

Measured vs. calculated capacity:

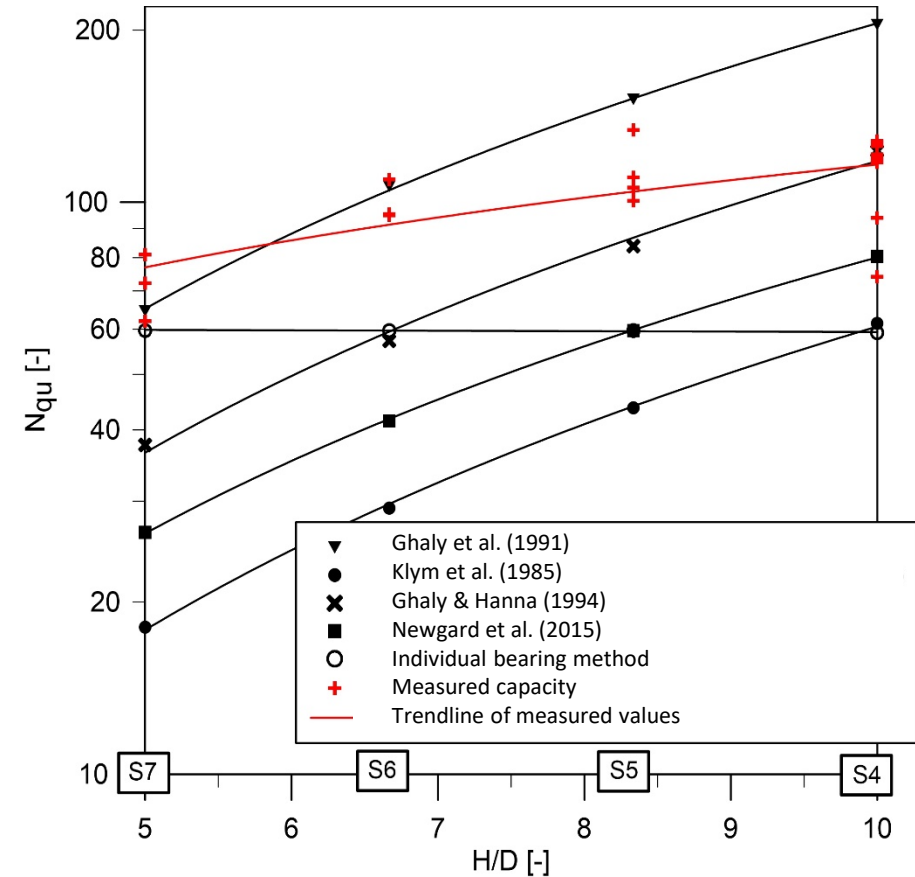

- Test results of similar magnitude to other small scale model tests, but cannot be predicted by available design methods.
- Significant influence of screwed installation for greater speeds expected; further possible scale effects and effect of water saturation to be investigated further.



Helical anchors for mooring floating devices

Anchor Behaviour under Cyclic Loading

Cyclic load characteristics and test program:

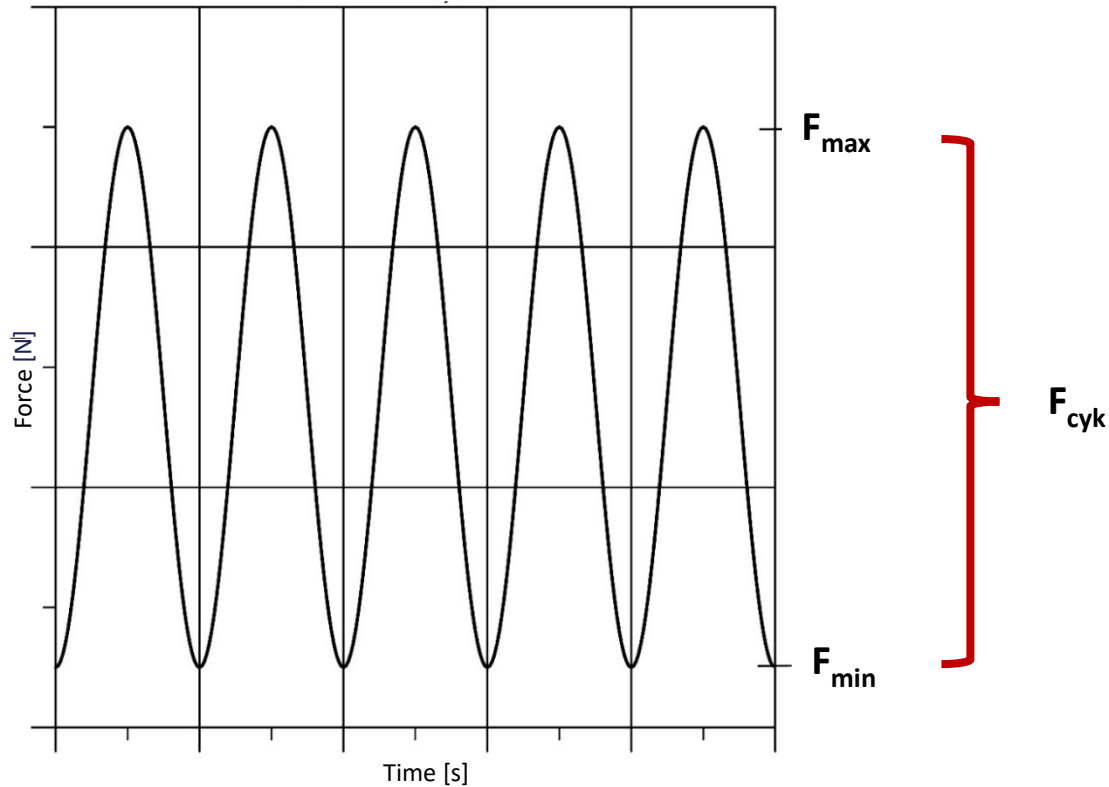

Definition of cyclic load ratio CLR:

$$\text{CLR} = \frac{F_{\text{cyk}}}{Q_{\text{U,Grenz}} - F_{\text{min}}} [-]$$

with: $F_{\text{cyk}} = F_{\text{max}} - F_{\text{min}}$

and: $F_{\text{min}} = \text{pre-stress}$

- Performance of multistage tests with anchor S4 ($D_{\text{Helix}} = 10 \text{ cm}$), placed during pluviation.
- CLR increased in steps: 0.05/0.10/0.15/0.20/0.25 [-].
- Each load level maintained for at least $N = 10,000$ cycles, frequency 0.167 Hz.
- Pre-stress of $F_{\text{min}}/Q_{\text{u}} = 0.00/0.05/0.10$, 3 tests for each pre-stress.

Helical anchors for mooring floating devices

Results of Cyclic Multistage Tests

- No progressive failure for tested CLR and numbers of cycles.
- Shakedown only for very small load levels.
- For higher load levels stabilization of accumulation process especially for a pre-stressed anchor.
- Pre-stressing improves anchor behaviour, but accumulated displacements continuously increase.
- Reproducibility of tests only limited.

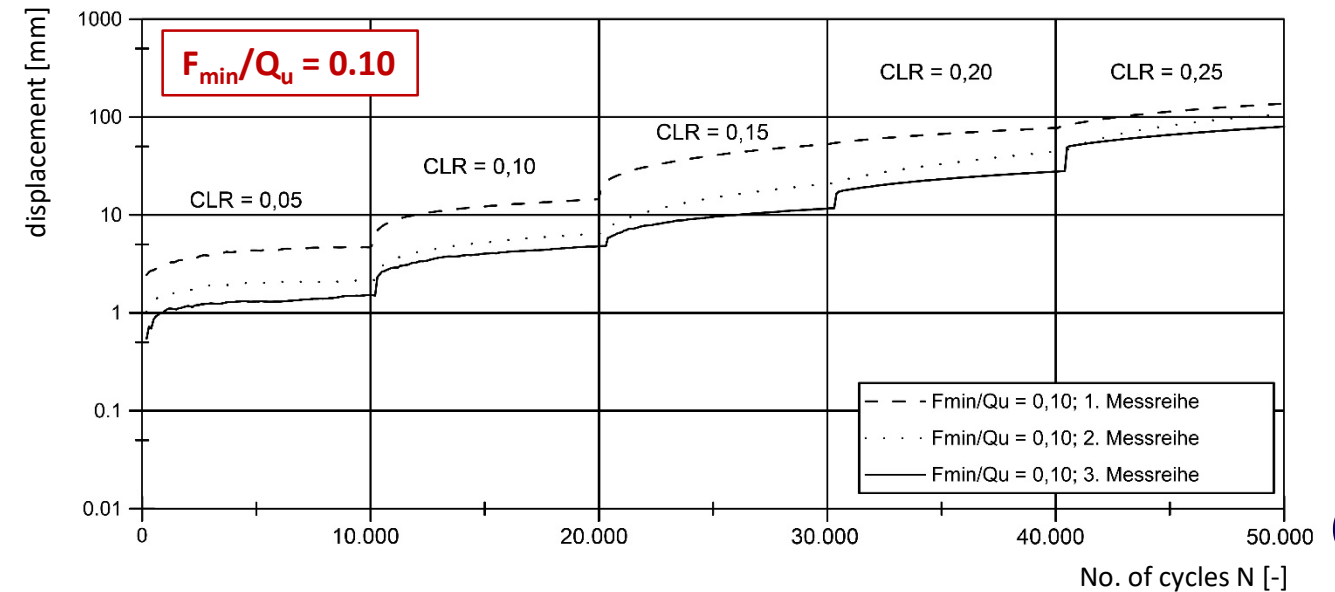
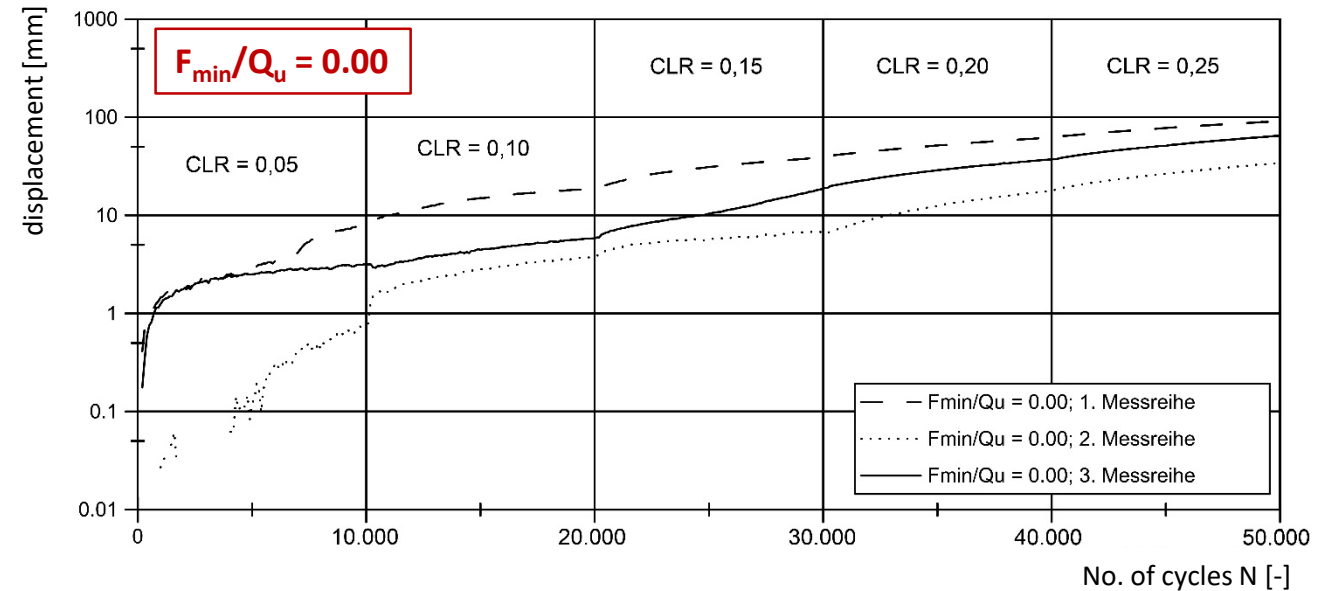

Helical anchors for mooring floating devices

Analysis of the Postcyclic Pullout Capacity

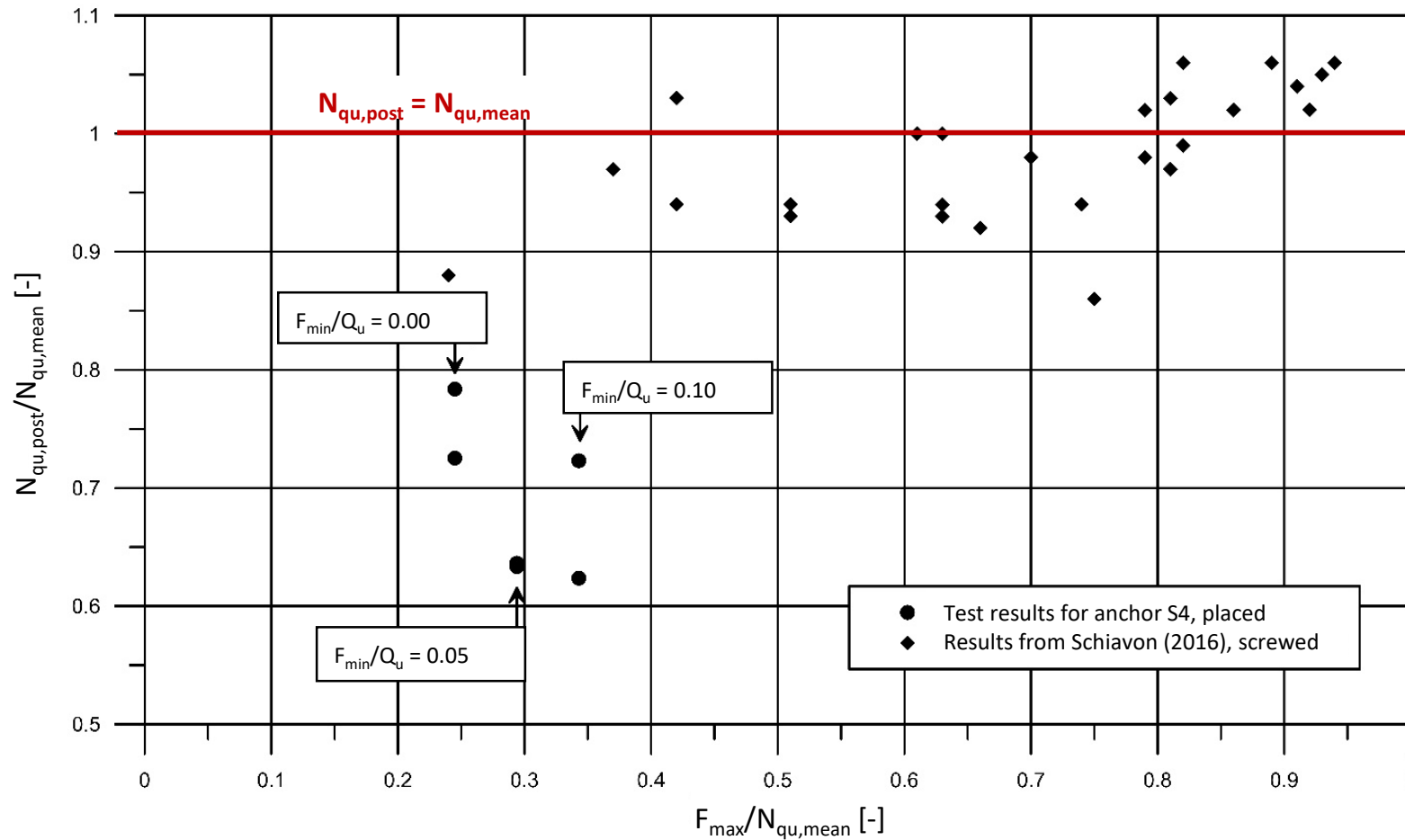

- Though different test conditions (e.g. effect of saturation, possible scale effects) a strong effect of the installation process on the measured pullout capacities is anticipated and needs to be investigated further.

Conclusion & Outlook

- Reliability of available design methods for pull out capacity of helical piles is very limited.
- Micro-mechanical behavior of anchors during generation of uplift resistance not fully understood, especially the contribution of helical plate and shaft; Moreover, long-term behavior under cyclic tensile loading - as typical for floating offshore structures - was rarely investigated.

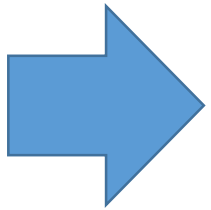

New Research: Analysis of micro-mechanical behaviour using Discrete Element Method

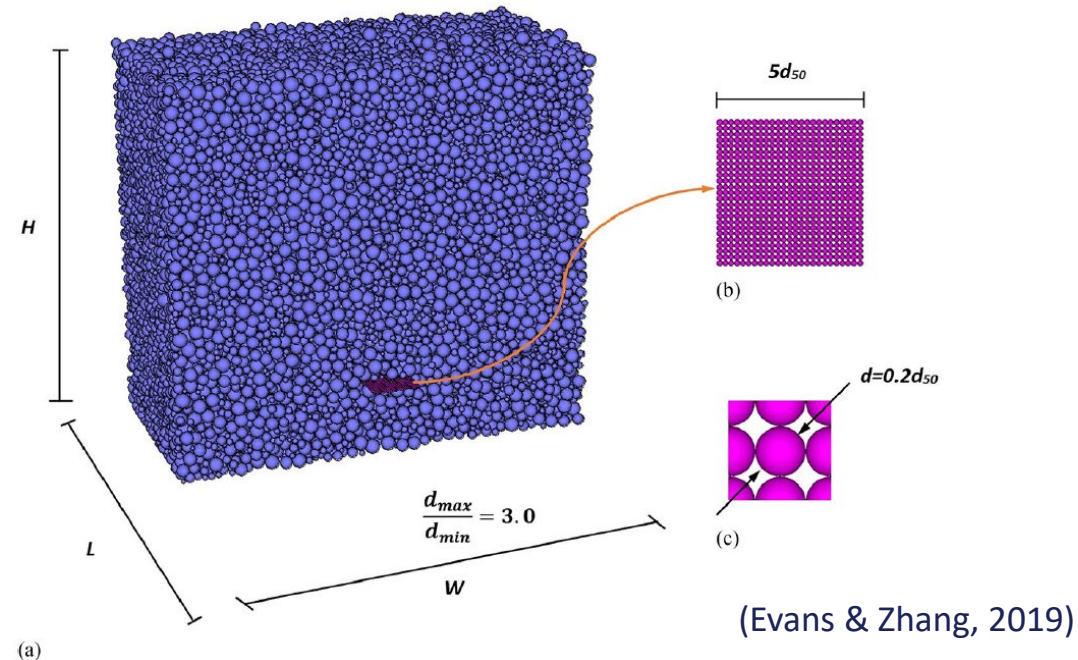

Conclusion & Outlook

Installed Nemos prototype converter and research tower



- Monopiles finally used for tower and pulley support points.
- Converter meanwhile decommissioned.
- Research tower now in the ownership of the West Flanders Development Agency – POM West-Vlaanderen.
- Used by different companies and research institutes as a measurement platform for various research related to blue energy.



Conclusion & Outlook

Project WindTide

Monopile with twin horizontal axis turbines:

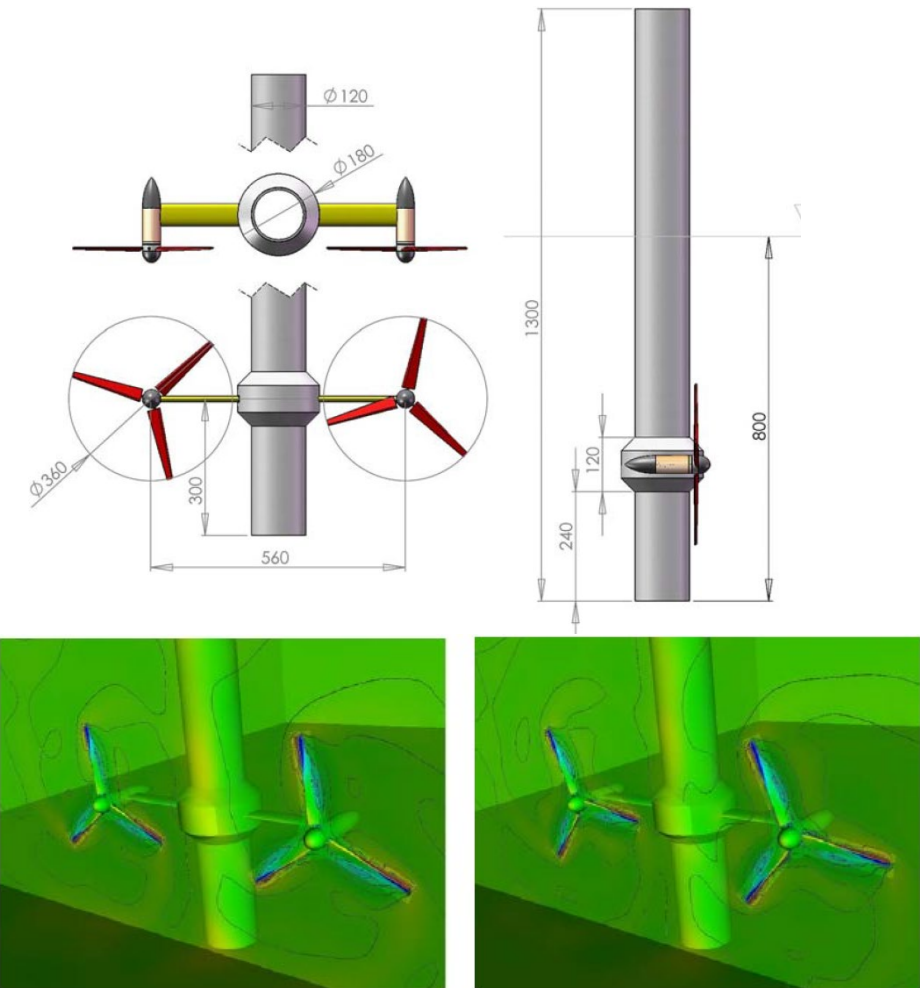

Tripod with vertical axis turbine:

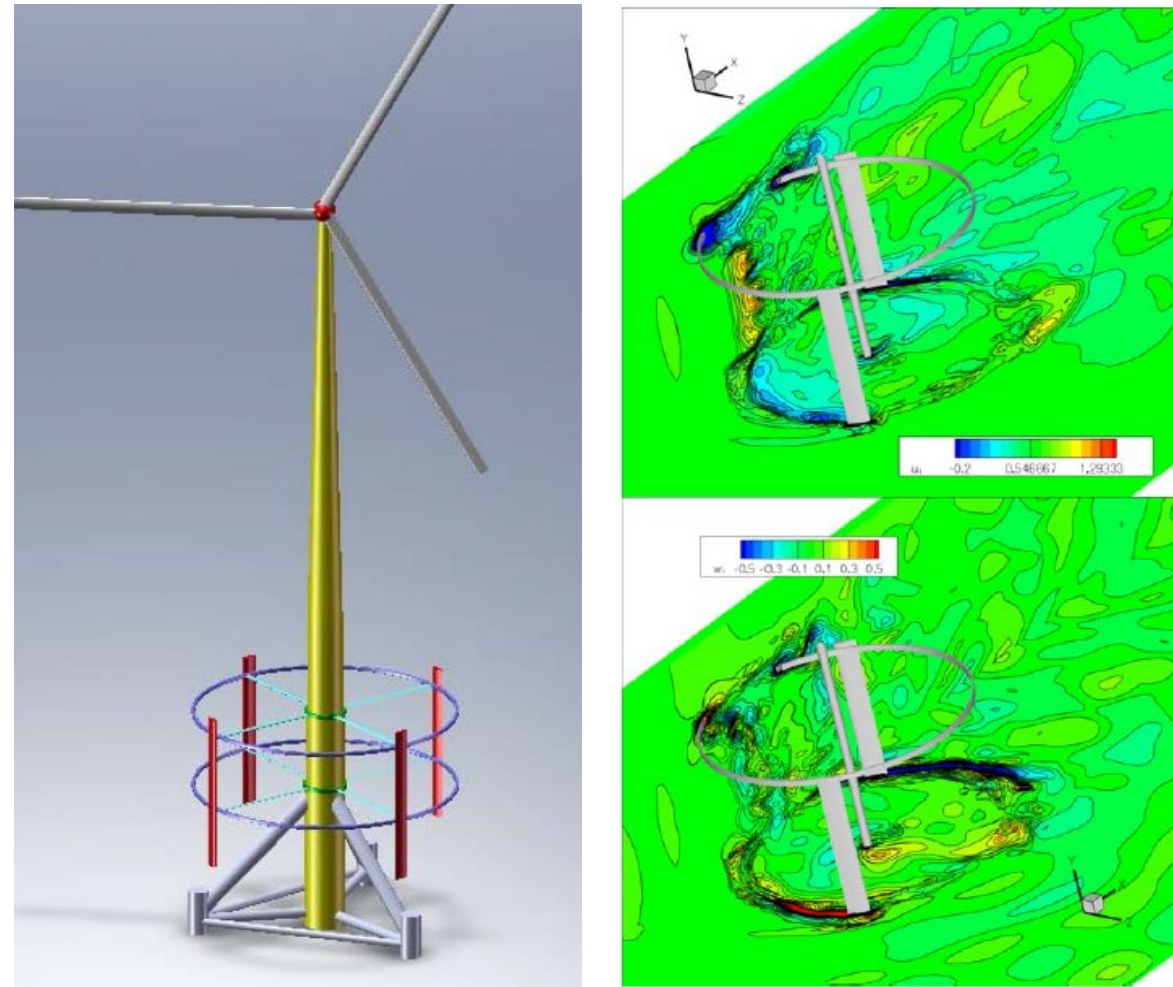

Thank you very much for your attention!

University of Siegen
Chair of Geotechnical Engineering
Paul-Bonatz-Str. 9-11
D-57076 Siegen

kerstin.lesny@uni-siegen.de

www.bau.uni-siegen.de/subdomains/geo

Our website: 

